



# The POWER of VISUAL COMMUNICATION

Katalog 2021

*Catalog 2021*



Leuchtkästen/-säulen / <i>Illuminated Products</i> 4 – 11	Einschubrahmen / <i>Slide-in Frames</i> 39	Schaukästen / <i>Display Cases</i> 70 – 71	Stehpulte / <i>Podiums</i> 113 – 114
Digital Signage / <i>Digital Signage</i> 12 – 16	Postersysteme / <i>Poster Holders</i> 40 – 41	Informations- und Schutzsysteme / <i>Information and protection systems</i> 72 – 91	Prospektdispenser / <i>Leaflet Dispensers</i> 115
Tablet Ständer / <i>Tablet Stands</i> 17	Infoständer / <i>Menuboards</i> 42 – 47	Bannersysteme / <i>Banner Systems</i> 92 – 94	Desktop Displays / <i>Desktop Displays</i> 116 – 121
Textil-Spannrahmen / <i>Textile Stretchframes</i> 18 – 23	Kundenstopper / <i>Pavement Signs</i> 48 – 62	Prospektständer / <i>Brochure Stands</i> 94 – 103	Office Produkte / <i>Office Products</i> 122-123
Outdoor Systeme / <i>Outdoor Systems</i> 24 – 29	Fahrradständer / <i>Bicyclestands</i> 63 – 66	Kombinationsständer / <i>Modular Stands</i> 104 – 107	Zubehör / <i>Accessories</i> 124
Klapprahmen Opti Frame/Magnet Posterrahmen 30 – 31 / <i>Snap Frames Opti Frame/Magnetic Popster Frame</i>	Plakatständer / <i>Info Stands</i> 66 – 67	Messeysteme / <i>Exhibition Displays</i> 108 – 109	
Klapprahmen / <i>Snap Frames</i> 32 – 38	Vintage Display, Dekoration und Licht / <i>Vintage Display, Decoration and Light</i> 68 – 69	Theken / <i>Counter Displays</i> 110 – 112	



Im Hoch- und Querformat nutzbar  
*Usable in portrait and landscape format*



LED



Made in Germany  
*Made in Germany*



Wasserfest – geeignet für den Außeneinsatz  
*Waterproof – suitable for outdoor use*



Grafikproduktion auf Anfrage möglich  
*Print on request available*



Made in Europe  
*Made in Europe*



Abschließbar  
*Lockable*



Web-basierte, vernetzte Lösung  
*Web-based, networking solution*



„CE-zertifiziert“  
*„CE-certified“*



Für den Inneneinsatz geeignet  
*Only suitable for indoor use*



Smart Home Steuerung  
*Smart home control*



Baukastensystem  
*Modular System*



Einfacher Plakatwechsel  
*Easy poster change*



Leicht  
*Light weight*



1 Jahr Gewährleistung  
*1 Year Warranty*



Sondergrößen möglich  
*Special sizes available*



Sehr standfest  
*Excellent stability*



Stand Alone/ Vernetzt  
*Stand Alone/ Crosslinked*



Grün = hoher Lagerbestand *Green = High Stock*  
Gelb = geringer Lagerbestand *Yellow = Low Stock*  
Rot= wird produziert *Red = In Production*



Ausleuchtung auf Wunsch bis 9.000 Lumen/m<sup>2</sup>  
*Illumination on request up to 9.000 lumen/m<sup>2</sup>*



Paketdienstfähig  
*Parcel service capable*



Schwer entflammbar  
*Flame resistant*



Anschließen und Loslegen  
*Plug & Play*



Patentiert  
*All rights reserved*

## LED Konvex Leuchtkasten | *LED Convex Lightbox*



- Konvex gewölbter Leuchtrahmen!
  - Einfacher Motivwechsel dank bewährter Klemmprofil-Technik
  - Rückseitige Ausleuchtung durch LED Module
  - Sonderformate und -farben auf Anfrage!
- *Outward curved lightbox!*
  - *Easy graphic change thanks to proved snap-profiles*
  - *Rear illumination by LED modules*
  - *Special sizes and colors on request!*

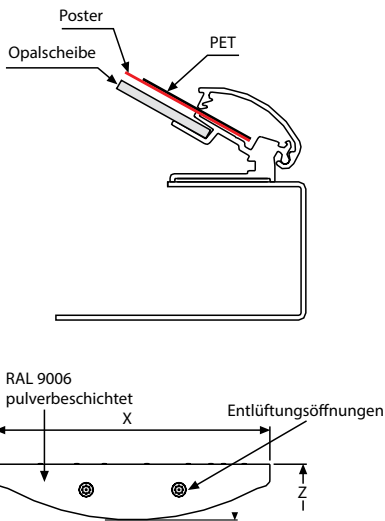

Art.-Nr.	Plakatmaß (mm)	Profilbreite (mm)	Ausleuchtung (Lux)	Watt
UCLB25LNA4X1000	210 x 297	25	1200	2
UCLB25LNA3X1000	297 x 420	25	1200	3
UCLB25LNA2X2000	420 x 594	25	800	8
UCLB25LNA1X1000	594 x 841	25	1100	10
UCLB25LNB2X2000	500 x 700	25	1000	7



**LED Leuchtrahmen 25/35 mm, einseitig** | LED lightframe 25/35 mm single-sided

- Einseitig beleuchtetes Display mit Klemmprofilen für schnellen Motivwechsel
- Bautiefe 19 mm, Profilbreite 25 mm
- Farbtemperatur 5600-6500 K
- Ausleuchtung durch Flächenlicht
- Ein-/Aus-Schalter am Rahmen und steckbares Netzteil
- Sondermaße bis zu 1200 x 2415 mm möglich
- Single-sided illuminated display with snap profiles for an easy change of graphic
- Depth 19 mm, snap profile 25 mm
- Color temperature 5600 - 6500 K
- Illumination by LGP
- On / off switch on the frame and pluggable power supply
- Special dimensions up to 1200 x 2415 mm available

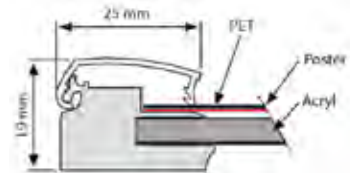
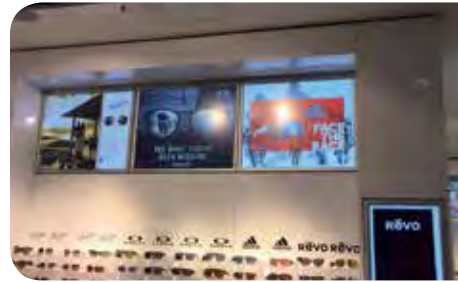

Art.-Nr.	Plakatmaß (mm)	Profilbreite (mm)	Bautiefe (mm)	Ausleuchtung (Lux)	Watt
ULD25TNOA4X1000	210 x 297	25	19	2000	6
ULD25TNOA3X1000	297 x 420	25	19	3300	18
ULD25TNOA2X1000	420 x 594	25	19	3300	23
ULD25TNOA1X1000	594 x 841	25	19	3000	35
ULD25TNOA0X1000	841 x 1189	25	19	2700	48
ULD25TNOB2X1000	500 x 700	25	19	3200	27
ULD25TNOB1X1000	700 x 1000	25	19	2800	41
ULD35TNOBOX1000	1000 x 1400	35	29	2300	58
ULD35TNO00X5114	1185 x 1750 (CityLight)	35	29	2000	73

**LED Leuchtrahmen 25 mm, einseitig, Economy** | LED lightframe 25 mm, single-sided, Economy

- Einseitig beleuchteter Klapprahmen für schnellen Motivwechsel
- Bautiefe 18 mm, Profilbreite 25 mm
- Farbtemperatur 5600-6500 K
- Ausleuchtung durch LED-Flächenlicht
- Sondermaße bis zu 800 x 1200 mm möglich
- Single-sided illuminated snapframe for a quick change of poster
- Construction depth 18 mm, profile width 25 mm
- Color temperature 5600-6500 K
- Illumination by LED LGP
- Special dimensions up to 800 x 1200 mm possible

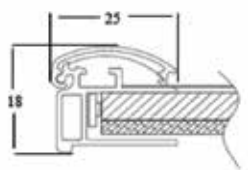

Art.-Nr.	Plakatmaß (mm)	Profilbreite (mm)	Farbe	Ausleuchtung (Lux)	Watt
ULB25TNOA4X2000	210 x 297	25	silber	3300	9,5
ULB25TNOA3X2000	297 x 420	25	silber	3000	14
ULB25TNOA2X2000	420 x 594	25	silber	2700	20
ULB25TNOA1X2000	594 x 841	25	silber	2100	28,5
ULB25TNOA0X2000	841 x 1189	25	silber	1800	40,5
ULB25TNOB2X2000	500 x 700	25	silber	2400	24
ULB25TNOB1X2000	700 x 1000	25	silber	2000	35
ULB25TBOA1X2000	594 x 841	25	schwarz	2100	28,5

## LED Leuchtrahmen 25 mm, doppelseitig, Economy | *LED lightframe 25 mm, double-sided, Economy*



- Doppelseitig beleuchteter Klapprahmen für schnellen Motivwechsel
- Bautiefe 30 mm, Profildbreite 25 mm
- Ausleuchtung durch LED-Flächenlicht
- Farbtemperatur 5600-6500 K
- Seilabhängung für Hoch- oder Querformat
- Sondermaße bis zu 800 x 1200 mm möglich

- *Double-sided illuminated snapframe for a quick change of poster*
- *Construction depth 30 mm, profile width 25 mm*
- *Color temperature 5600-6500 K*
- *Illumination by LED LGP*
- *Suspension wire set for portrait and landscape application*
- *Special dimensions up to 800 x 1200 mm possible*

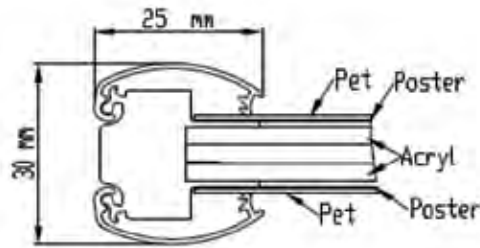

Art.-Nr.	Plakatmaß (mm)	Ausleuchtung (Lux)	Watt	Farbe
ULB25CNOA4X2000	210 x 297	3000	9,5	silber
ULB25CNOA3X2000	297 x 420	2600	14	silber
ULB25CNOA2X2000	420 x 594	2300	20	silber
ULB25CNOA1X1000	594 x 841	2000	28,5	silber
ULB25CNOA0X1000	841 x 1189	1400	40,5	silber
ULB25CN0B2X2000	500 x 700	2200	24	silber
ULB25CN0B1X2000	700 x 1000	1800	35	silber
ULB25CBOA1X2000	594 x 841	2000	28,5	schwarz

## AcryLED Posterdisplay, doppelseitig | AcryLED Posterdisplay, double sided

- Hohe Leuchtkraft ermöglicht eine brillante Farbwiedergabe
  - Gute Fernwirkung auch bei Tageslicht durch 4000 Lux Ausleuchtung und leuchtende Kanten
  - Einfaches Handling durch magnetische Klapptasche
  - Stromführung durch Seilsystem – keine sichtbaren Kabel
  - Hochwertige, chromfarbene Befestigungselemente
  - Netzteil wird an Alu-Deckenschiene angeschlossen
- 
- *High brightness enables brilliant color reproduction*
  - *Eyecatching long-distance effect even in daylight with 4000 lux illumination and glowing edges*
  - *Easy handling thanks to magnetic poster-pocket*
  - *Power supply through wire system - no visible cables*
  - *High quality chrome colored fasteners*
  - *Power supply is connected to ceiling rail*



Art.-Nr.	Plakatformat (mm)	Ausleuchtung (Lux)
1185065	594 x 841	2500
1185068	500 x 700	3000
1185067	700 x 1000	2000

## LuxLED Leuchtsäule | *LuxLED Totem*



- Doppelseitig beleuchtetes Display mit stabiler Fußplatte
- Brillante Ausleuchtung durch LED-Flächenlicht
- Einfacher Diawechsel durch innovative Magnettechnik
- Optional Branding auf Displayfläche oder Fußplatte
- Schwarzes oder silbernes Passepartout

- *Double-sided illuminated display with stable base plate*
- *Brilliant illumination by LED LGP*
- *Easy change of graphic thanks to magnetic closure*
- *Optional branding on display area or base plate*
- *Black or silver passe-partout*



Art.-Nr.	Plakatmaß (mm)	Watt
UMLD37B000X2000	594 x 1682	66
UMLD37COB1X5000	700 x 1000	39
UMLD37COA1X5000	594 x 841	33

## Konvex Leuchtsäule | *Convex Totem*



- Freistehende Leuchtsäule auf ovalem Standfuß
- Einfacher Motivwechsel dank seitlicher Klemmprofile
- Lieferung erfolgt demontiert mit einfacher Aufbauanleitung
- Beleuchtung durch Leuchtstoffröhren und Acrylopalscheiben
- Budget Version ohne Klemmprofile alternativ

- *Freestanding light column with oval base*
- *Simple motif change thanks to lateral clamping profiles*
- *Delivery disassembled with simple assembly instructions*
- *Illumination by fluorescent tubes and opal acrylic glass*
- *Budget version without clamping profiles alternatively*

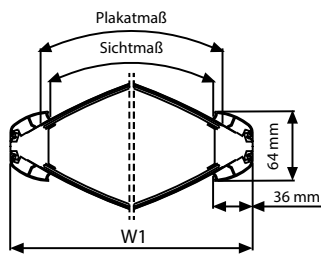

**Deckelplatte**  
RAL 9006 pulverbeschichtet

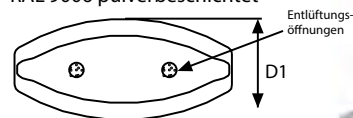

Art.-Nr.	Plakatmaß (mm)	Watt
UTTM001000X1050	600 x 1700	1 x 58
UTTM002000X1050	700 x 1700	1 x 58
UTTM003000X1050	800 x 1700	2 x 58



## LED Infodisplay AcryLED Magic Digital | LED Info Display AcryLED Magic Digital

- Freistehendes Display aus verchromtem Stahl
  - Kabelausgang befindet sich in der Fußplatte
  - Variable Bestückung mit DIN A4, DIN A3 Rahmen oder 21" Screen mit Mediaplayer
  - Rahmen werden mit rückseitigen Magneten am System fixiert und leuchten auf
  - Einfacher Grafikwechsel durch Einschub der Motive
  - Gesamthöhe 2000 mm
  - Content upload über USB Stick oder 4 G
  - Software für vernetzte Anwendung auf Anfrage
  - Permanentes Branding auf Anfrage
- *Free-standing display in chromed steel finish*
  - *Cable exit are located in the baseplate*
  - *Allows variable use with DIN A4, DIN A3 frames or 21" Digital Signage Screen*
  - *Frames are fixed to the system with back magnets and light up when connected*
  - *Simple graphic change by insertion of graphic*
  - *Total height 2000 mm*
  - *Content upload via USB stick or WIFI*
  - *Software for web-based solutions request*
  - *Optionally with permanent branding*

Art.-Nr.	Ausführung	Format (mm)	Watt	Lux	
1185058	Gestell für Standversion	250 x 2000 x 400			
1185060	Gestell für Wandversion	220 x 2000			
1185056	AcryLED Magic Rahmen, DIN A4	210 x 297	4,5	5000	
1185057	AcryLED Magic Rahmen, DIN A3	297 x 420	10	5000	
1185059	Netzteil		50		
1185061	Netzteil		100		
1185062	Netzteil		150		
1185063	Top-Schild, poliert	190 x 240			
1185064	Beschriftung Top-Schild				
Art.-Nr.	Ausführung	Auflösung	Beschreibung	Zoll	Nit
1185077	Digital Signage Screen mit Mediaplayer	1920 x 1080	Anschlüsse 1 x HDMI; 1 x USB	21,5	2000

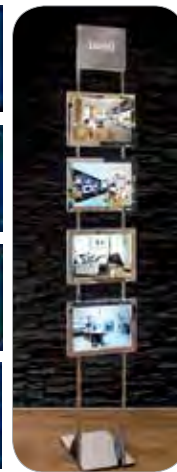

Standversion  
Querformat  
Stand version  
landscape



Standversion  
verschiedene Formate  
Stand version  
different formats



Wandversion  
Querformat  
Wall version  
landscape

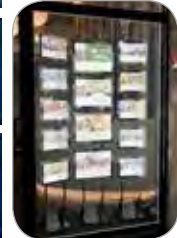

Magnetische Befestigung  
Magnetic fixation



Diawechsel  
Slide change

## AcryLED Leuchtrahmen, doppelseitig | AcryLED lightframe, double sided

- Ultraflacher Leuchtrahmen für ein - oder doppelseitige Schaufenster-Anwendung
  - Einfacher Grafikwechsel durch magnetische PET-Tasche
  - Leuchtende Kanten sorgen für zusätzliche Aufmerksamkeit
  - Brillante Ausleuchtung von etwa 4000 LUX durch lasergravierte Acrylscheibe
  - Silberner Passepartoutrahmen
  - Keine Kabel sichtbar, Stromversorgung erfolgt über Stahlseile
- *Ultra thin design allowing single or double sided use in shopwindows*
  - *Easy graphic change by magnetic PET-pocket*
  - *Glowing edges create extra attention*
  - *Brilliant illumination approx. 4000 LUX by laser engraved acrylic panel*
  - *Silver passepartout frame*
  - *Innovative suspension kit*
  - *No cables visible, power is supplied by steel wire*



Art.-Nr.	Plakatformat	Ausführung
1185055	4 x DIN A4 hoch	Deckenabhängung
1185032	8 x DIN A4 hoch	Deckenabhängung
1185033	12 x DIN A4 hoch	Deckenabhängung
1185034	3 x DIN A3 quer	Deckenabhängung
1185035	6 x DIN A3 quer	Deckenabhängung



## LED Magnetrahmen Economy, einseitig | *LED Magnetic Frame Economy, single-sided*



- LED Leuchtrahmen im TFT Look
  - Superflache Bautiefe von nur 13 mm!
  - Homogene und brillante Ausleuchtung
  - Bewährtes LED-Flächenlicht
  - Einfacher Posterwechsel durch Magnettechnik mit Griffmulde
- *Eye-catching, illuminated presentation in TFT look*
  - *Very slim- depths only 13 mm!*
  - *Practical magnetic protection cover for easy poster change*
  - *Finger hole to push cover*
  - *High and even illumination by LGP*



Art.-Nr.	Plakatmaß (mm)	Ausleuchtung (Lux)	Watt
ULDMEN0BA4X2000	210 x 297	3600	12
ULDMEN0BA3X2000	297 x 420	3300	18
ULDMEN0BA2X2000	420 x 594	3000	23
ULDMEN0BA1X2000	594 x 841	2600	35
ULDMEN0BA0X2000	841 x 1189	1800	48
ULDMEN0BB2X2000	500 x 700	2500	27
ULDMEN0BB1X2000	700 x 1000	2100	41

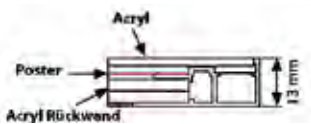

## LED Magnetrahmen Economy, doppelseitig | *LED Magnetic Frame Economy, double-sided*



- Doppelseitiges Leuchtdisplay im TFT Look
  - Extrem flache Bautiefe von nur 20 mm!
  - Homogene und brillante Ausleuchtung durch LED-Flächenlicht
  - Seilset kann für Anwendung im Hoch- oder Querformat genutzt werden
- *Double-sided LED magnetic frame in TFT look*
  - *Depth only 20 mm!*
  - *Cable outlet as standard on a short side together with ceiling suspension wire-set for use in portrait or landscape position*
  - *Absolutely homogeneous and brilliant illumination by LED LGP*



Art.-Nr.	Plakatmaß (mm)	Ausleuchtung (Lux)	Watt
ULDMEN0BA4X2000	210 x 297	3000	9,5
ULDMEN0BA3X2000	297 x 420	2600	14
ULDMEN0BA2X2000	420 x 594	2300	20
ULDMEN0BA1X2000	594 x 841	2000	28,5
ULDMEN0BA0X2000	841 x 1189	1400	40,5
ULDMEN0BB2X2000	500 x 700	2200	24
ULDMEN0BB1X2000	700 x 1000	1800	35

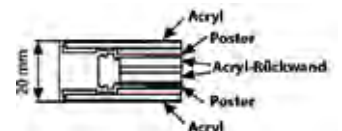

## LED Magnetrahmen, einseitig | LED Magnetic Frame, single-sided

- LED Leuchtrahmen im TFT Look
- Bautiefe von nur 24 mm!
- Homogene und brillante Ausleuchtung durch LED-Flächenlicht
- Einfacher Posterwechsel durch Magnettechnik mit Öffnungsknopf
- Ein-/ Aus-Schalter am Rahmen und steckbares Netzteil

- LED light-frame in TFT look
- Construction depth of only 24 mm!
- High and even illumination by laser engraved acrylic panel
- Easy poster change by magnetic cover with opening button
- Comes with on / off switch and pluggable power supply

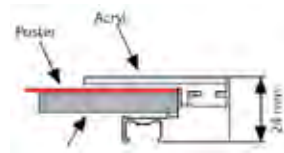

Art.-Nr.	Plakatmaß (mm)	Ausleuchtung (Lux)	Watt
ULDMON00A4X2000	210 x 297	6000	12
ULDMON00A3X2000	297 x 420	5400	18
ULDMON00A2X2000	420 x 594	4900	23
ULDMON00A1X2000	594 x 841	3800	35
ULDMON00A0X2000	841 x 1189	3200	48
ULDMON00B2X2000	500 x 700	4300	27
ULDMON00B1X2000	700 x 1000	3300	41



## LED BrandSign | LED BrandSign

- Ideal für die Markenwerbung
- Graviertes oder geritztes Acrylglas mit Folienplot oder Digitaldruck
- Rundes Alu-Profil mit leistungsstarken LED
- Freistehend oder für die Deckenabhängung

- Ideal for brand advertising
- Laser engraved acrylic glass with plot or digital print
- Aluminum profile with integrated LED
- Desktop or for ceiling suspension

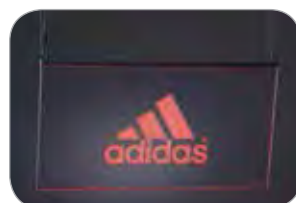

## DigiStand Alone Kundenstopper | Digistand Alone A-Board

- **Auspacken – an das Stromnetz anschließen – Content laden – Digital Signage nutzen!**

- Professionelles SAMSUNG Digital Signage Display
- SOC Mediaplayer und 4 Core CPU und 8 GB Speicher
- Elegantes Gehäuse aus pulverbeschichtetem Stahlblech
- USB oder WLAN Content Upload
- Lizenzfrei – keine Folgekosten für Software
- Erhältlich in silbergrau, weiß oder schwarz
- Abschliessbar

- **Unpack - connect to the mains - load content - use digital signage!**

- Professional SAMSUNG digital signage display
- SOC media player and 4 core CPU and 8 GB of memory
- Elegant housing made of powder-coated steel
- USB or WLAN content upload
- Royalty-free - no follow-up costs for software
- Available in silver gray, white or black
- Lockable



Art.-Nr.	Anwendung	Farbe	Screen	Display	Gestell	Ausführung	Abmessung (mm)
1191009	StandAlone	silbergrau	43"	Samsung PM43H	Mit Laufrollen	Full HD 1080 x 1920	670 x 1.150 x 500
1191013	Stand Alone	schwarz	43"	Samsung QMR43R	Ohne Laufrollen	Ultra 4 HDK	635 x 1.280 x 405
1191014	Stand Alone	weiß	43"	Samsung QMR43R	Ohne Laufrollen	Ultra 4 HDK	635 x 1.280 x 405

## Digitale Stele Vario Modul | Digital Stand Vario Modul

- Durchdachtes Baukastensystem für die Umsetzung individueller Digital Signage Stelen, -Abhängesystemen oder Bestandteil von Shop-in-Shop Systemen
  - Das 100 mm tiefe Rahmenprofil mit umlaufender Systemnut kann variabel Screens bis zu 55 Zoll aufnehmen und flexibel mit Panels aus Kunststoff-, Alu-Verbundplatten, Sicherheitsglas oder Textildrucken individuell gestaltet und gebrandet werden
  - Die Innenkonstruktion mit der VESA -Halterung ist vormontiert, das IT-Display kann vor Ort einfach eingebaut und per Plug & Play in Betrieb genommen werden
  - Auch eine spätere Umgestaltung oder Erweiterung des Systems ist Dank der modularen Bauweise möglich
- *Smart modular system for individual digital signage totems or hanging systems*
  - *Ideal also as Shop-in-shop systems*
  - *100 mm profile with inbuilt groove*
  - *Can be used for screens up to 55 inches*
  - *Customization with panels made of plastic, wood, tempered glass, metal or textile prints*
  - *Interior design with the VESA mount is pre-Assembled*
  - *IT display can be easily installed on site and put into operation via Plug & Play*
  - *Later conversion or extension of the system is possible thanks to the modular design*

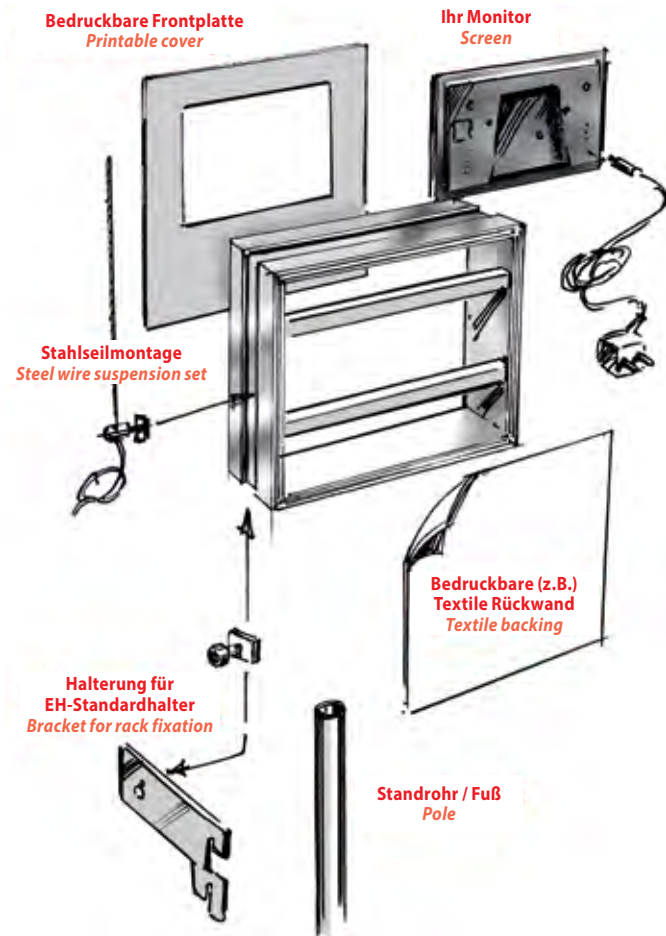

Informationen auf Anfrage / informations on request

## Digital Signage Stele LuxDIGITAL 75 | Digital Signage Stand LuxDIGITAL 75



- Auspacken – an das Stromnetz anschließen – Content laden – DIGITAL SIGNAGE nutzen!
- Flache, einseitige Indoor-Stele mit nur 70 mm Bautiefe
- Robustes Gehäuse aus eloxiertem Aluminium mit Frontscheibe aus Sicherheitsglas
- Samsung Digital Signage Display für 24/7 Betrieb
- Lizenzfreie „Magic Info Express“ Software für Stand Alone Anwendungen
- Intuitive Bedienung und viele Templates für ein einfaches Content Design
- Content upload über USB, WIFI oder 4G
- Unterstützt alle gängigen Dateiformate
- Optional vernetzte Anwendung über Cloud-basierte Easy Signage Software
- Sehr standfest dank schwerer Stahl-Fußplatte
- Abschließbare Rückwand
- Integriertes Belüftungssystem

- *Unpack - connect to the mains - load content - use DIGITAL SIGNAGE!*
- *Flat, single-sided indoor totem with only 70 mm construction depth*
- *Sturdy anodised aluminum housing with safety glass front panel*
- *Samsung Digital Signage Display for 24/7 use*
- *Licence-free "Magic Info Express" software for stand-alone applications*
- *Intuitive operation and many templates for easy content design*
- *Content upload via USB, WIFI or 4G*
- *Optional networked application via cloud-based Easy Signage software*
- *Very stable thanks to heavy steel base plate*
- *Lockable back wall*
- *Integrated ventilation system*



Art.-Nr.	Anwendung	Farbe	Screen	Display	Ausführung	Helligkeit (nit)	Abmessung (mm)
1191016	StandAlone	schwarz	43"	Samsung QMR43R	Ultra 4 HDK	500	725 x 2025 x 500
1191017	StandAlone	schwarz	55"	Samsung QMR55R	Ultra 4 HDK	500	920 x 2150 x 550

## Digital Signage Stele LuxDIGITAL 200, doppelseitig | Digital Signage Stand LuxDIGITAL 200, double sided

- Auspacken – an das Stromnetz anschließen – Content laden - Digital Signage nutzen!
- Doppelseitige Indoor-Stele mit 200 mm Bautiefe
- Robustes Gehäuse aus eloxiertem Aluminium mit Frontscheiben aus Sicherheitsglas
- Samsung Digital Signage Displays für 24/7 Betrieb – getrennt ansteuerbar
- Lizenzfreie „Magic Info Express“ Software für Stand Alone Anwendungen
- Intuitive Bedienung und viele Templates für ein einfaches Content Design
- Content upload über USB, WIFI oder 4G
- Unterstützt alle gängigen Dateiformate
- Optional vernetzte Anwendung über Cloud-basierte Easy Signage Software
- Sehr standfest dank schwerer Stahl-Fußplatte
- Integriertes Belüftungssystem

- *Unpack - connect to the mains - load content - use digital signage!*
- *Double-sided indoor totem with a construction depth of 200 mm*
- *Sturdy anodized aluminum housing with safety glass front panels*
- *Samsung Digital Signage Displays for 24/7 operation – can be used separately*
- *License free "Magic Info Express" software for stand-alone applications*
- *Intuitive operation and many templates for easy content design*
- *Content upload via USB, WIFI or 4G*
- *Supports all popular file formats*
- *Optional networked application via cloud-based Easy Signage software*
- *Very stable thanks to heavy steel base plate*
- *Integrated ventilation system*



Art.-Nr.	Anwendung	Farbe	Screen	Display	Ausführung	Helligkeit (nit)	Abmessung (mm)
1191018	StandAlone	schwarz	43"	Samsung QMR43R	Ultra 4 HDK	500	725 x 2025 x 650
1191019	StandAlone	schwarz	55"	Samsung QMR55R	Ultra 4 HDK	500	920 x 2150 x 800

Digital Signage Stele LuxDIGITAL Outdoor | Digital Signage Stand LuxDIGITAL Outdoor



- Einseitige Outdoor-Stele mit 200 mm Bautiefe
- Robustes Gehäuse aus eloxiertem Aluminium, Schutzklasse IP 56
- Frontscheibe aus IK 10 Sicherheitsglas mit Graffiti Schutz
- Samsung Digital Signage Outdoor-Display für 24/7 Betrieb
- Die Helligkeit wird über einen Sensor stromsparend gesteuert
- Lizenzfreie „Magic Info Express“ Software für Stand Alone Anwendungen
- Intuitive Bedienung und viele Templates für ein einfaches Content Design
- Content upload über USB, WIFI oder 4G
- Unterstützt alle gängigen Dateiformate
- Optional vernetzte Anwendung über Cloud-basierte Easy Signage Software
- Schwere Stahl-Fußplatte für Bodenverankerung
- Integriertes Belüftungssystem im Gehäuse und selbstkühlendes System im Display

- *One-sided outdoor totem with a construction depth of 200 mm*
- *Robust housing made of anodised aluminum, protection class IP 56*
- *Front cover made of IK 10 safety glass with graffiti protection*
- *Samsung Digital Signage outdoor display for 24/7 operation*
- *The brightness is controlled by a sensor to save energy*
- *License free "Magic Info Express" software for stand-alone applications*
- *Intuitive operation and many templates for easy content design*
- *Content upload via USB, WIFI or 4G*
- *Supports all popular file formats*
- *Optional networked application via cloud-based Easy Signage software*
- *Heavy steel foot plate for ground anchoring*
- *Integrated ventilation system in the housing and self-cooling system in the display*



Art.-Nr.	Anwendung	Farbe	Screen	Display	Ausführung	Helligkeit (nit)	Abmessung (mm)
1191020	StandAlone	schwarz	46"	Samsung OH46F	Full HD 1080 x 1920	2500	780 x 2015 x 220
1191021	StandAlone	schwarz	55"	Samsung OH55F	Full HD 1080 x 1920	2500	890x2150 x 210

Digitales Schaufensterdisplay VARIO 100 | Digital Shopwindow Display VARIO 100

- Auspacken – aufhängen - an das Stromnetz anschließen – Content laden - Digital Signage nutzen!
- Einseitiges, digitales Display mit nur 100 mm Bautiefe
- Robustes Gehäuse aus eloxiertem Aluminium mit schwarzem Passepartout aus Alu-Verbundplatte
- Samsung Digital Signage Display für 24/7 Betrieb
- Lizenzfreie „Magic Info Express“ Software für Stand Alone Anwendungen
- Intuitive Bedienung und viele Templates für ein einfaches Content Design
- Content Upload über USB, WIFI oder 4G
- Optional vernetzte Anwendung über Cloud-basierte Easy Signage Software
- Hochwertige Deckenabhängung mit Stahlseilen (Galeriegüte)
- Dekorative textile Rückwand – kann auch werblich genutzt werden

- *Unpack - suspend - connect to the power grid - load content - use digital signage!*
- *Single sided digital display with only 100 mm depth*
- *Sturdy frame made of anodized aluminum with black passpartout made of aluminum composite panel*
- *Samsung digital signage display for 24/7 operation*
- *License-free "Magic Info Express" software for stand-alone applications*
- *Intuitive operation and many templates for a simple content design*
- *Content upload via USB, WIFI or 4G*
- *Optional networked application via cloud-based easy signage software*
- *High quality ceiling suspension made of steel wire (gallery quality)*
- *Decorative textile backing - can also be used for advertising*



## Easy Signage Software für vernetzte, web-basierte Lösungen |

*Easy Signage Software for web-based networking solutions*

- Cloud-basierte Software zur zentralen Steuerung und Darstellung digitaler Inhalte
  - Regionale Anpassbarkeit für flexible Werbung
  - Zeitsteuerung ermöglicht frühzeitige Planung
  - LTE Anbindung macht die Nutzung überall möglich wo Strom verfügbar ist
  - Einfache Bedienbarkeit über Smartphone - kein IT Personal benötigt
  - Display benötigt nur HDMI Eingang
- *Web-based software for central control and presentation of digital content*
  - *Regional adaptability for flexible advertising*
  - *Time control allows early planning*
  - *LTE connectivity makes it possible to use anywhere where power is available*
  - *Easy to use via Smartphone – no IT staff required*
  - *Display only needs HDMI plug*



## NEU! EasySignage PLUS Software | *EasySignage PLUS Software*

- **Ultrakompakte Plug & Play Lösung!**
- Viele Playlisten-Templates
- Beliebig editierbar durch den WYSIWYG Editor
- Der Editor kann über den lokalen Browser oder über das lokale Netzwerk bedient werden
- Sie benötigen keinerlei Softwareinstallation, noch nicht einmal eine Netzwerk für den temporären Einsatz auf Messen oder Events
- Ideal für Kleinere Geschäfte wie z.B. stationärer Einzelhandel, Tankstellen, Hotels, Handwerksbetriebe, Immobilienbüros, Dienstleister, etc.
- Messen und Veranstaltungen für temporäre Nutzung
- **Zur Bedienung des Editors wird kein Netzwerk benötigt, somit sind nicht vorhandene oder überlastete W-LAN Netzwerke auf Messen und Veranstaltungen kein Problem mehr**
- Ultrakompakter robuster Signage Player mit Windows 10
- gleichzeitig bis zu 2 Displays (HDMI und DP) mit bis zu 4K UHD nutzbar
- Leistungsfähiges iChannel CMS mit WYSIWYG Content Editor und einer Vielzahl von Playlisten-Templates, die über den lokalen Browser oder über das lokale Netzwerk bedient werden können
- Player Software, die per Autostart selbständig startet und bis zu 2 Monitore (HDMI und DP) bedienen kann



- **Ultra-compact Plug & Play solution!**
- *Many playlist templates*
- *Unlimited editable with the WYSIWYG editor*
- *The editor can be operated via the local browser or via the local network*
- *You do not need any software installation, not even a network for temporary use at fairs or events*
- *Perfect solution for smaller businesses such as stationary retail stores, petrol stations, hotels, craft businesses, real estate agencies, service providers, etc.*
- *Trade fairs and events for temporary use*
- **No network is required to operate the editor, so non-existent or overloaded W-LAN networks at trade fairs and events are no longer a problem**
- *Ultra-compact Signage Player with Windows 10*
- *Up to 2 displays (HDMI and DP) with up to 4K UHD can be used simultaneously*
- *Powerful iChannel CMS with WYSIWYG content editor and a variety of playlist templates that can be operated via the local browser or the local network*
- *Player software that starts automatically by autostart and can operate up to 2 monitors (HDMI and DP)*



## Tablet Ständer FRAME | *Tablet Stands FRAME*

- Funktionale Bodenständer für digitale Kiosk-Anwendungen im Hoch- oder Querformat
  - Für alle gängigen Tablets im Format 9,7" bis 10,1"
  - Abschließbares Tablet Gehäuse aus Kunststoff
  - Aluminium-Standrohr mit stabiler Fußplatte
  - USB-Ladekabel und Drahtseil-Schloss zur Diebstahl-Sicherung des Ständers optional
  - Auf Wunsch auch als Wandversion oder Kombinationsständer erhältlich
- *Functional floor stands for digital kiosk applications in portrait or landscape format*
  - *For all tablets in the format 9.7" to 10.1"*
  - *Lockable, black tablet case made of plastic*
  - *Aluminium upright profile with stable base plate*
  - *Optionally, USB charging cable and wire rope lock for theft protection of the stan*
  - *Also available as wall version or combination stands*



Flexibler Tablet Ständer  
*Flexible Tablet Stand*



Gewölbter Tablet Ständer  
*Curved Tablet Stand*



Novel Tablet Ständer  
*Novel Tablet Stand*

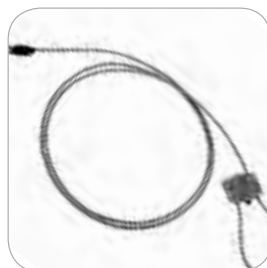

Drahtseil-Schloss  
*Wire rope lock*

Art.-Nr.	Modell	Maß/ Beschreibung
UUTF0N0B00X2000	Flexibler Tablet Ständer	9,7 Zoll bis 10,1 Zoll
UUTN0N1B00X2000	Novel Tablet Ständer	9,7 Zoll bis 10,1 Zoll
UUTC0B1B00X2000	Gewölbter Tablet Ständer	9,7 Zoll bis 10,1 Zoll
Zubehör		
TZZZ998701X2000		Kabel-Schloss 2.100 mm, mit Schlaufe und Zahlencode
TSTD0C1450BX2000		Ladekabel iPhone 4 und 5
TSTD0C800BX2000		Ladekabel Samsung V8

## Textil-Spannrahmen MaxiFrame 15 | *Textile Stretchframe MaxiFrame 15*



- Einseitig bespannbarer Textilrahmen
- Bautiefe 15 mm
- Für kleinere Formate zur Wandmontage
- Größere Formate müssen alle 500 mm verschraubt werden
- Demontierte Lieferung

- *Single-sided textile frame*
- *Construction depth 15 mm*
- *Ideal for wall mounting of small sizes*
- *Large sizes need to be fixed all 500 mm*
- *Comes knocked down*

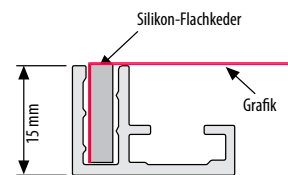

Art.-Nr.	Format (mm)
UMFR0000A2X1000	420 x 594
UMFR0000A1X1000	594 x 841
UMFR0000B2X1000	500 x 700
UMFR0000B1X1000	700 x 1000
UMFR000510X1000	500 x 1000



Version mit abgerundeten Ecken auf Anfrage! / *Rounded corners on request.*

## Textil-Spannrahmen MaxiFrame 32 | *Textile Stretchframe MaxiFrame 32*



- Einseitig bespannbarer Textilrahmen
- Bautiefe 32 mm
- Speziell für den Einbau in Nischen oder Rahmen aus Holz
- Versteifung durch H-Profil möglich
- Demontierte Lieferung

- *Single-sided textile frame*
- *Construction depth 32 mm*
- *Best suited for installation in niches or wooden frames*
- *Stabilization by H-profile possible*
- *Comes knocked down*

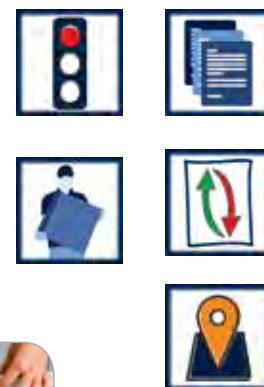

Einbau in Holzrahmen  
*Installation in wooden frame*

Art.-Nr.	Format (mm)
UMFB0000A1X1000	594 x 841
UMFB0000A0X1000	841 x 1189
UMFB0000B2X1000	500 x 700
UMFB0000B1X1000	700 x 1000
UMFB0000B0X1000	1000 x 1400
UMFB000510X1000	500 x 1000
UMFB001010X1000	1000 x 1000
UMFB001015X1000	1000 x 1500
UMFB001020X1000	1000 x 2000

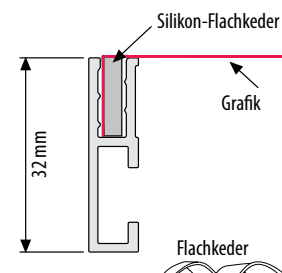

## Textil-Spannrahmen MaxiFrame 34 | Textile Stretchframe MaxiFrame 34

- Einseitig bespannbarer Textilrahmen aus stabilem Hohlkammerprofil
- Bautiefe 34 mm
- Rückseitig umlaufende Befestigungs-Nut
- Versteifung durch H-Profil möglich
- Demontierte Lieferung

- *Single-sided textile frame made of sturdy hollow-chamber profile*
- *Construction depth 34 mm*
- *Rear inbuilt fixing groove*
- *Stabilization by H-profile possible*
- *Comes knocked down*

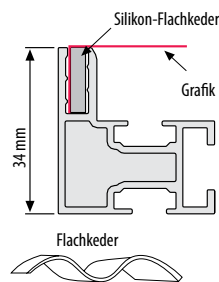

Art.-Nr.	Format (mm)
UMFG001020X1000	1000 x 2000
UMFG001030X1000	1000 x 3000
UMFG001520X1000	1500 x 2000
UMFG001530X1000	1500 x 3000
UMFG002020X1000	2000 x 2000
UMFG002030X1000	2000 x 3000

## Textil-Spannrahmen MaxiFrame 50 | Textile Stretchframe MaxiFrame 50

- Doppelseitig bespannbarer Textilrahmen aus stabilem Hohlkammer-Profil
- Bautiefe 50 mm
- Umlaufende Nut zur Befestigung von Füßen oder Abhängesystemen
- Versteifung durch H-Profil möglich
- Bei einseitigem Lichteinfall wird Block-Out Material empfohlen
- Demontierte Lieferung

- *Double-sided textile frame made of sturdy hollow-chamber profile*
- *Construction depth 50 mm*
- *Inbuilt groove for fixation of feet or wire set*
- *Stabilization by H-profile possible*
- *For unilateral incident light, block-out material is recommended*
- *Comes knocked down*

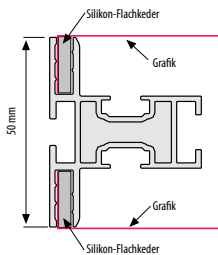
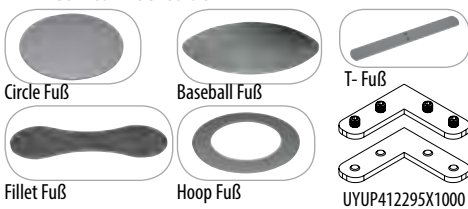

Art.-Nr.	Format (mm)
UMFO001014X1000	1000 x 1400
UMFO001015X1000	1000 x 1500
UMFO001020X1000	1000 x 2000
UMFO001022X1000	1000 x 2250
UMFO002015X1000	2000 x 1500
UMFO002020X1000	2000 x 2000
UMFO002022X1000	2000 x 2250
UMFO003015X1000	3000 x 1500
UMFO003020X1000	3000 x 2000
UMFO003022X1000	3000 x 2250

Art.-Nr.	Produkt	Außenmaß (mm)	Gewicht (kg)
UYUP412274X1000	Fillet Fuß	500 x 180 x 6	3,3
UYUP412271X1000	Circle Fuß	∅ 450 x 6	7,5
UYUP412273X1000	Baseball Fuß	450 x 300 x 6	4,7
UYUP412272X1000	Hoop Fuß	∅ 450 x 6	4,4
UYUP412275X2000	T- Fuß	450 x 50 x 5	4,0



# Textil-Spannrahmen | *Textile Stretchframes*

## MaxiFrame Wood | *MaxiFrame Wood*



- 40 mm breiter Textilspannrahmen aus Buche-Vollholz, dunkel lasiert
- Integrierte Nut für Flachkeder
- Produziert aus zertifiziertem Buchenholz
- Erhältlich als demontierbarer Rahmen oder auch als Profillänge
- Doppelseitige Ausführung auf Anfrage

- 40 mm wooden textile stretch frame, dark lacquered
- Inbuilt groove for silicone lip
- Made of certified beech wood
- Available as knocked down frame or in profile lengths
- Double sided version on request

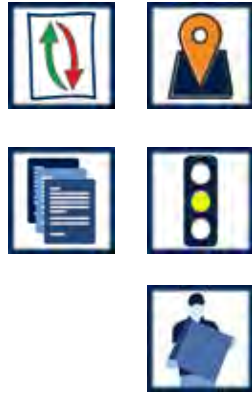

Art.-Nr.	Beschreibung	Plakatmaß (mm)
UMFWOD01A2X2000	Rahmen	420 x 594
UMFWOD01A1X2000	Rahmen	594 x 841
UMFWOD01A0X2000	Rahmen	841 x 1189
UMFWOD01B2X2000	Rahmen	500 x 700
UMFWOD01B1X2000	Rahmen	700 x 1000
UMFWOD01B0X2000	Rahmen	1000 x 1400
UYPMFWD020X2000	Profil	2000
UYPMFWOC00X2000	Eckverbinder; Set	

## Textil-Spannrahmen MaxiFrame LED 20 | *Textile Stretchframe MaxiFrame LED 20*



- Superflacher LED-Textilspannrahmen!
- Nur 20 mm Bautiefe!
- Farbintensive Ausleuchtung durch LED Flächenlicht
- Wandbefestigung mit Z-Schiene
- Externes Netzteil
- Maximalformat 1000 x 1400 mm

- Super flat LED textile frame!
- 20 mm depth only!
- Color-intensive illumination by LED lightpanel
- Wall mounting by Z-rail
- External power supply
- Maximum Size 1000 x 1400 mm

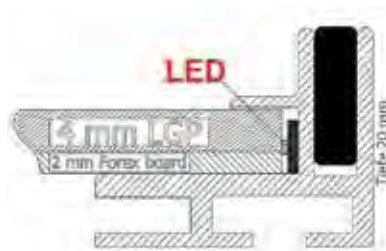

Art.-Nr.	Format (mm)	Watt
1240069	420 x 594	20
1240077	594 x 841	28,5
1240078	841 x 1189	40,5
1240079	500 x 700	24
1240080	700 x 1000	35
1240081	1000 x 1400	48



## Textil-Spannrahmen MaxiFrame LED 45, einseitig | *Textile Stretchframe MaxiFrame LED 45, single sided*

- Ideal geeignet für Wandmontage von mittleren Formaten
  - Sehr homogene Hinterleuchtung durch LED Module
  - Bei Seitenlängen über 1500 mm demontierte Lieferung für kostengünstigen Versand
  - Einfache Montage mit Steckverbindern
  - Maximalformat 2000 x 3000 mm
  - Optional mit Smart Home Steuerung
  - Ausleuchtung auf Wunsch bis 9000 Lumen/m<sup>2</sup>
- 
- *Ideal for wall application of medium sizes*
  - *Bright illumination by rear LED modules*
  - *Side lengths over 1500 mm come disassembled for cost-effective shipping*
  - *Easy assembly with plug connectors*
  - *Maximum Size 2000 x 3000 mm*
  - *Optionally with Smart Home control*
  - *Illumination on request up to 9000 lumen/m<sup>2</sup>*



Art.-Nr.	Format (mm)	Watt
1249044	1000 x 2000	120
1249045	1500 x 2500	270
1249046	2000 x 2000	290
1249043	2000 x 3000	340

## Textil-Spannrahmen MaxiFrame LED 50, doppelseitig | *Textile Stretchframe MaxiFrame LED 50, double-sided*

- Bautiefe 50 mm
  - Doppelseitig für Deckenabhängung oder als Standmodell
  - Ideal für kleine Formate
  - Textildruck leicht austauschbar
  - Brillante Ausleuchtung durch LED-Flächenlicht
  - Maximalformat 1000 x 2000 mm
  - Optional mit Smart Home Steuerung
- 
- *Construction depth 50 mm*
  - *Double-sided as floor model or for ceiling suspension of small sizes*
  - *Easy change of textile prints*
  - *Bright and even illumination by LGP*
  - *Maximum Size 1000 x 2000 mm*
  - *Optionally with Smart Home control*

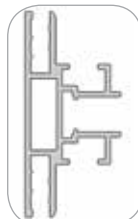

Art.-Nr.	Format (mm)	Watt	Inklusive
UMLSCN00A2X2000	420 x 594	20	Seilset
UMLSCN00A1X2000	594 x 841	28,5	Seilset
UMLSCN00A0X2000	841 x 1189	40,5	Seilset
UMLSCN00B2X2000	500 x 700	24	Seilset
UMLSCN00B1X2000	700 x 1000	35	Seilset
UMTLN02A1X2000	594 x 1682	54	Fußplatte

## Textil-Spannrahmen MaxiFrame LED 100 Power, einseitig |

*Textile Stretchframe MaxiFrame LED 100 Power, single-sided*

- Bautiefe 100 mm
  - Einseitig als Wand-, Decken oder Standmodell für XXL-Formate
  - Textildruck leicht austauschbar
  - Kantenbeleuchtung durch leuchtstarke LED-Module
  - Textile Block-Out Rückwand für kostengünstigen Transport
  - Maximalformat 2800 x 6000 mm
  - Optional mit Smart Home Steuerung
  - **Optional mit rückseitigen LED Modulen für eine Ausleuchtung bis zu 9000 Lumen/m<sup>2</sup>**
- *Construction depth 100 mm*
  - *Single-sided as wall, ceiling or floor model for XXL formats*
  - *Easy change of textile print*
  - *Edge lighting by high-intensity LED modules*
  - *Textile block-out backing for cost-effective transportation*
  - *Maximum Size 2800 x 6000 mm*
  - *Optional with smart home control*
  - **Optionally with rear LED modules for illumination up to 9000 lumens/m<sup>2</sup>**



Art.-Nr.	Format (mm)	Watt
1244004	2000 x 2000	102
1249058	2000 x 3000	210
1244006	2500 x 4000	280

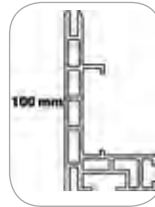

## Textil-Spannrahmen MaxiFrame LED 100 Power, doppelseitig |

*Textile Stretchframe Maxi Frame LED 100 Power, double-sided*

- Bautiefe 100 mm
  - Doppelseitig für die Deckenabhängung oder als Standmodell
  - Textildruck leicht austauschbar
  - Kantenbeleuchtung durch leuchtstarke LED-Module
  - Umlaufende Außen Nut zur Befestigung von Zubehör wie Füßen, Seilabhängung oder Prospektboxen
  - Maximalformat 2000 x 4000 mm
  - *Optional mit Smart Home Steuerung*
- *Construction depth 100 mm*
  - *Double - sided for ceiling suspension or as floor model*
  - *Easy change of textile prints*
  - *Edge lighting by high-intensity LED modules*
  - *Inbuilt groove for fixation of accessories*
  - *Maximum Size 2000 x 4000 mm*
  - *Optionally with Smart Home control*



Art.-Nr.	Format (mm)	Watt
1249065	800 x 2000	36
1249037	1000 x 2000	40
1240107	2000 x 2000	40



## Textil-Spannrahmen MaxiFrame LED 130 Schaufenster | Textile Stretchframe MaxiFrame LED 130 Backload

- Ermöglicht Grafikwechsel auch in schlecht zugänglichen Schaufenstern und spart damit Platz
- Textildruck leicht von hinten austauschbar
- Kantenbeleuchtung durch leuchtstarke LED-Module
- Doppelseitige Bespannung möglich
- Bei einseitiger Anwendung mit textiler Block-Out Rückwand
- Maximalformat 2500 x 4000 mm
- Optional mit Smart Home Steuerung

- *Allows graphics changes even in poorly accessible shop windows, thus saving space*
- *Textile printing easily replaceable from the back*
- *Edge lighting through high-intensity LED modules*
- *Can be used also double sided*
- *For single-sided application with textile block-out backing*
- *Maximum Size 2500 x 4000 mm*
- *Optionally with Smart Home control*

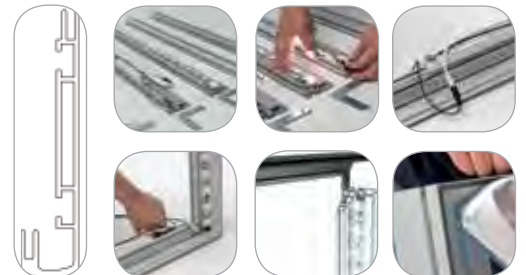

Art.-Nr.	Format (mm)	Watt
1239001	800 x 2000	36
1239002	1000 x 2000	40
1239003	2000 x 2000	95
1239004	3000 x 2000	140

## MaxiFrame LED GO | MaxiFrame LED GO

- Mobiles Leuchtdisplay mit hoher Leuchtkraft und gleichmäßiger, schattenfreier Ausleuchtung
- Das System wird demontiert geliefert und dank spezieller Eckverbinder mit ein paar Handgriffen werkzeuglos aufgebaut
- Magnetisches Verbindungssystem erlaubt die Erweiterung mehrerer Elemente zu einem großflächigen System
- Bautiefe 80 mm
- Robuste Transportverpackung mit Tragegriff
- Gepolsterte Tragetasche inklusive

- *Mobile illuminated display with bright and even illumination due to lateral mounted*
- *The system comes knocked down and thanks to special corner connectors, the set up without tools is made in a few simple steps*
- *Magnetic connection system allows the extension of several elements into a large-area graphic system*
- *Depth 80 mm*
- *Robust transport packaging with carrying handle*
- *Comes with padded carry-on bag*

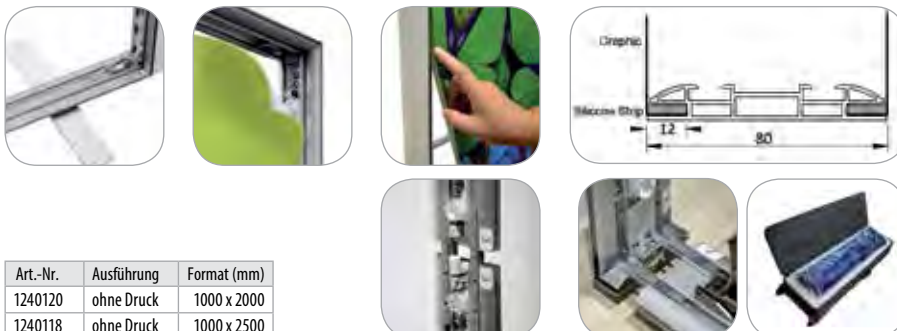

Art.-Nr.	Ausführung	Format (mm)
1240120	ohne Druck	1000 x 2000
1240118	ohne Druck	1000 x 2500



## MaxiFrame LED 90 Outdoor | MaxiFrame LED 90 Outdoor



- Sturmsicheres Flachkeder-Profilsystem für den Außenbereich
  - Durch den bewährten Klapp-Mechanismus wird der Textildruck auch bei Wind und Wetter zuverlässig gehalten
  - Ideal für Flächen mit wechselnden Werbebotschaften
  - Ausleuchtung durch seitliche oder rückseitige LED Module, IP 65
  - Netzteil innenliegend
  - Lieferung demontiert als Bausatz
- *Storm-proof profile system for outdoor use*
  - *Thanks to the proven snapframe technology textile prints are reliably maintained even in wind and weather*
  - *Ideal for applications with changing advertising messages*
  - *Illumination through lateral or rear LED modules, IP 65*
  - *Power supply inside*
  - *Comes knocked down as a kit*

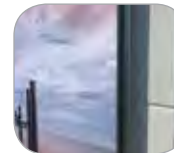
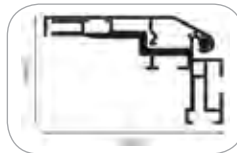

## Außen-Leuchtkästen | Outdoor Lightbox



- Rahmen aus silberfarbigen Alu-Hohlkammerprofilen
  - Ausführung mit opaler Haube, eingelegter Opalscheibe oder Aluminium-Klapprahmen
  - Erhältlich als einseitige Wandversion oder doppelseitiges Auslegertransparent
  - Bedruckung gemäß Vorgabe
  - Ausleuchtung durch unterschiedliche LED Techniken, abhängig von Größe und Einsatzzweck
  - Montage durch einen konzessionierten Elektrobetrieb auf Anfrage
- *Frame made of silver-colored aluminum hollow profile*
  - *Optionally with cap, flat opal glass or aluminum snap-frame*
  - *Single-sided or double-sided version*
  - *Printing according to specification*
  - *Illumination by different LED techniques, depending on size and purpose*
  - *Installation by a licensed electric company on request*





## LED Leuchtrahmen Outdoor 35 mm | LED lightframe Outdoor 35 mm

- Wasserfester Leuchtrahmen
  - Verschließbare 35 mm Klemmprofile, silber eloxiert
  - Bautiefe 29 mm
  - IP 67 Netzteil
  - Übergroße Schutzfolie und umlaufende Dichtung auf dem Unterprofil
  - LED's in Silikon eingeklebt
  - Maximalformat 1900 x 1000 mm
- *Waterproof LED snapframe*
  - *Lockable 35 mm snap profiles*
  - *Construction depth 29 mm*
  - *IP 67 power supply*
  - *Oversized protective film and seal on back profile*
  - *LED glued in silicone*
  - *Maximum format 1900 x 1000 mm*



Art.-Nr.	Plakatmaß (mm)	Ausleuchtung (Lux)	Watt
ULH35TNOA2X2000	420 x 594	2100	23
ULH35TNOA1X1000	594 x 841	1900	35
ULH35TNOA0X1000	841 x 1189	1500	48
ULH35TNOB2X1000	500 x 700	1900	27
ULH35TNOB1X1000	700 x 1000	1700	41
ULH35TNOB0X1000	1000 x 1400	1500	58

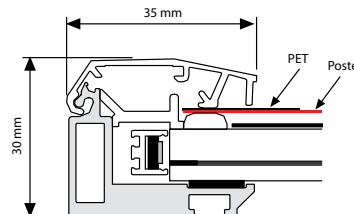

## Photovoltaik Außenwerbung | Photovoltaic outdoor advertisement



- PHOTOVOLTAISCHE SOLARSYSTEME FÜR DIE AUSSENWERBUNG
  - Hier stehen Umweltschutz und erneuerbare Energien im Mittelpunkt!
  - Zukunftssichere und saubere Alternative zur konventionellen Stromversorgung
  - Nutzt die Kraft der Sonne und spart Energiekosten
  - Kein Montageaufwand für die Stromversorgung
  - Werbung kann an jeder beliebigen Stelle platziert werden
  - Hochmoderne Solarpanels
  - Batterie wird tagsüber aufgeladen und liefert nachts elektrische Energie für die Werbung
  - Dämmerungssensoren steuern das Einschalten der Beleuchtung
  - Die LED's sind äußerst robust gegen äußere Faktoren wie Hitze, Kälte oder Feuchtigkeit
- *PHOTOVOLTAIC SOLAR SYSTEMS FOR OUTDOOR ADVERTISEMENT*
  - *Focus on environmental protection and renewable energies!*
  - *Future-proof and clean alternative to conventional power supply*
  - *Use the power of the sun and save energy costs*
  - *No installation work for the power supply*
  - *Advertising can be placed anywhere*
  - *State of the art solar panels*
  - *Battery is charged during the day and provides electrical energy for advertising at night*
  - *Twilight sensors control the switching on of the lighting*
  - *The LEDs are extremely robust against external factors such as heat, cold or moisture*



## Beachflag Segelform | Sail Flag

- Beachflag in Segelform aus Aluminium und Fiberglas
- Erhältlich in drei Größen
- Fußlösungen optional

- Beach flag in sail version made of aluminium and glass fiber
- Available in 3 sizes
- Feet solutions optional

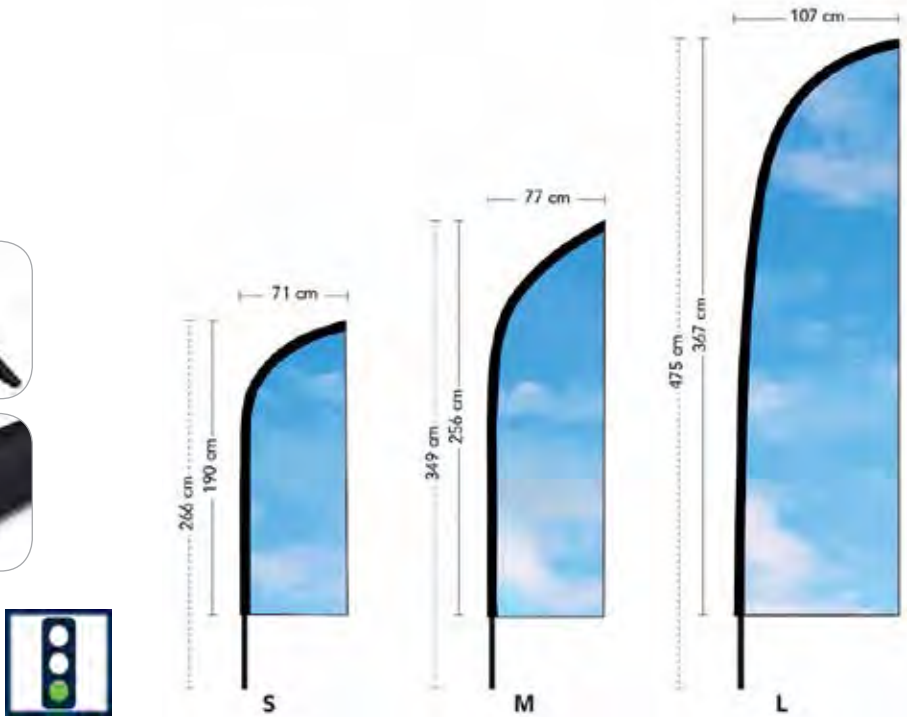

Art.-Nr.	Gesamtmaß (mm)	Flaggenmaß (mm)	Größe	Beschreibung
1802005	710 x 2660	705 x 1900	S	System
1802006	770 x 3490	770 x 2560	M	System
1802007	1070 x 4750	1067 x 3668	L	System
3260015	-	705 x 1900	S	Druck
3260016	-	770 x 2560	M	Druck
3260017	-	1067 x 3668	L	Druck



## Beachflag Tropfenform | Drop Flag

- Beachflag in Tropfenform aus Aluminium und Fiberglas
- Erhältlich in vier Größen
- Fußlösungen optional

- Beach flag in dropl version made of aluminium and glass fiber
- Available in 4 sizes
- Feet solutions optional

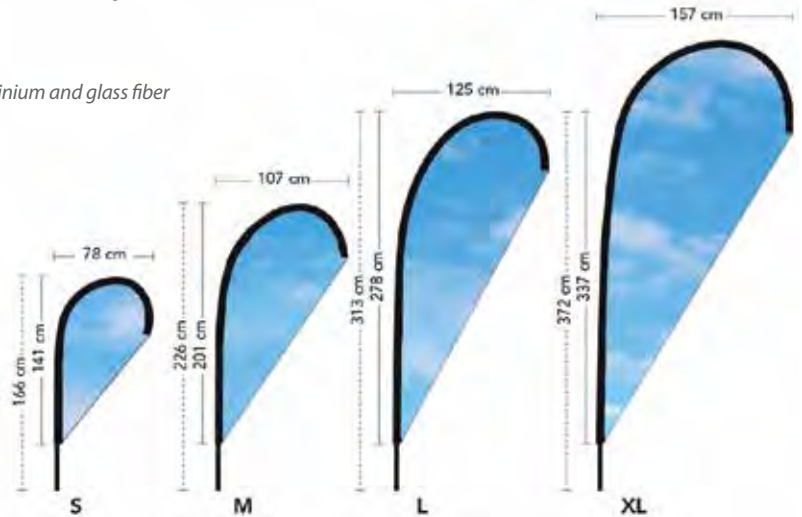

Art.-Nr.	Gesamtmaß (mm)	Flaggenmaß (mm)	Größe	Beschreibung
1802001	780 x 1660	775 x 1405	S	System
1802002	1070 x 2260	1070 x 2012	M	System
1802003	1250 x 3130	1245 x 2775	L	System
1802004	1570 x 3720	1565 x 3370	XL	System
3260011	-	775 x 1405	S	Druck
3260000	-	1070 x 2012	M	Druck
3260013	-	1245 x 2775	L	Druck
3260014	-	1565 x 3370	XL	Druck



## Beachflag Rechteckform | Square Flag

- Beachflag in Rechteckform aus Aluminium und Fiberglas
  - Erhältlich in drei Größen
  - Fußlösungen optional
- Beach flag in square version, made of aluminium and glass fiber
  - Available in three sizes
  - Feet solutions optional

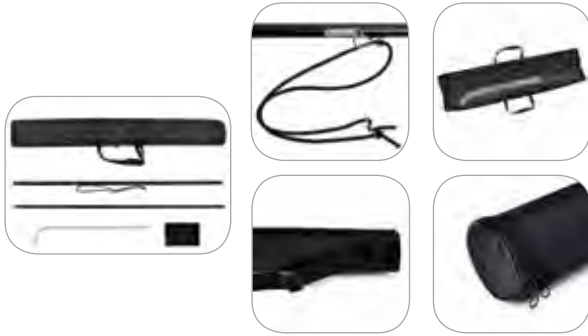

Art.-Nr.	Gesamtmaß (mm)	Flaggenmaß (mm)	Größe	Beschreibung
1802008	680 x 1700	675 x 1700	S	System
1802009	790 x 3440	790 x 2780	M	System
1802010	900 x 4500	900 x 3830	L	System
3260018	-	675 x 1700	S	Druck
3260019	-	790 x 2780	M	Druck
3260020	-	900 x 3830	L	Druck

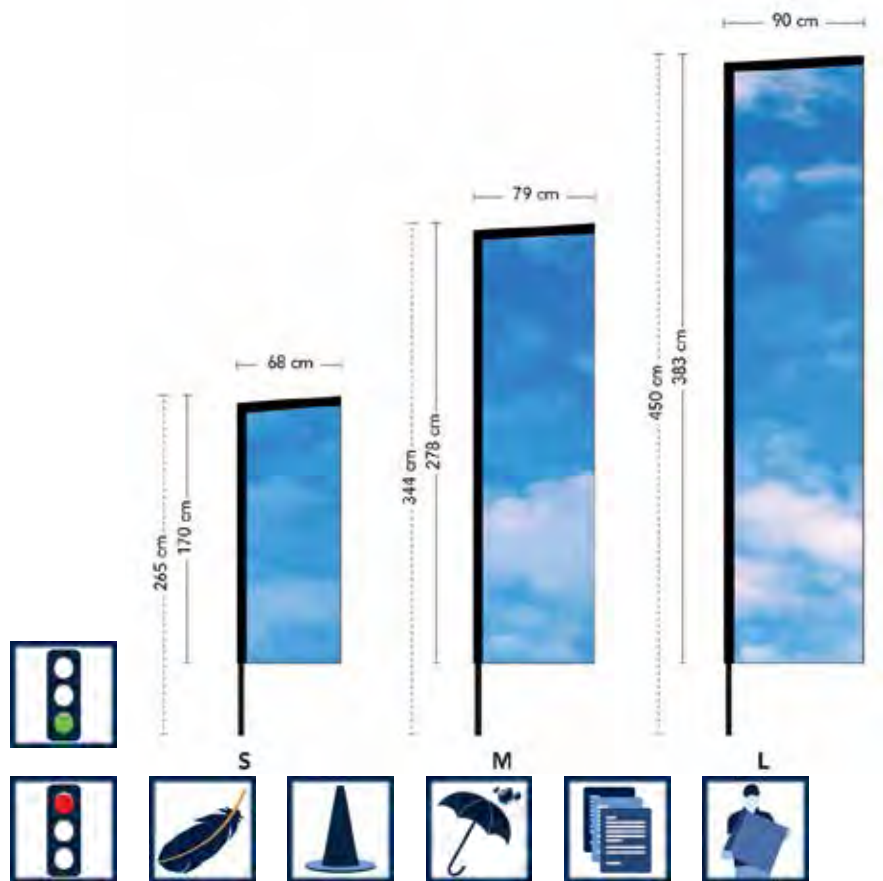

## Beachflag Fußlösungen | Flag Feet Options

- Erdlochbohrer mit Transporttasche
- Erdnagel mit Transporttasche
- Wasserfuß mit Transporttasche
- Stahl-Fußplatte mit Transporttasche
- Kreuzfuß mit Transporttasche
- Wasserbeutel

- Burrow digger with bag
- Burrow pin with bag
- Water tank with bag
- Square steel base with bag
- Cross-foot with bag
- Water bag

Art.-Nr.	Beschreibung
2802001	Erdlochbohrer
2802002	Erdnagel
2802003	Wasser-Fuß
2802004	Stahl-Fußplatte
2802005	Kreuzfuß
2802006	Wasserbeutel

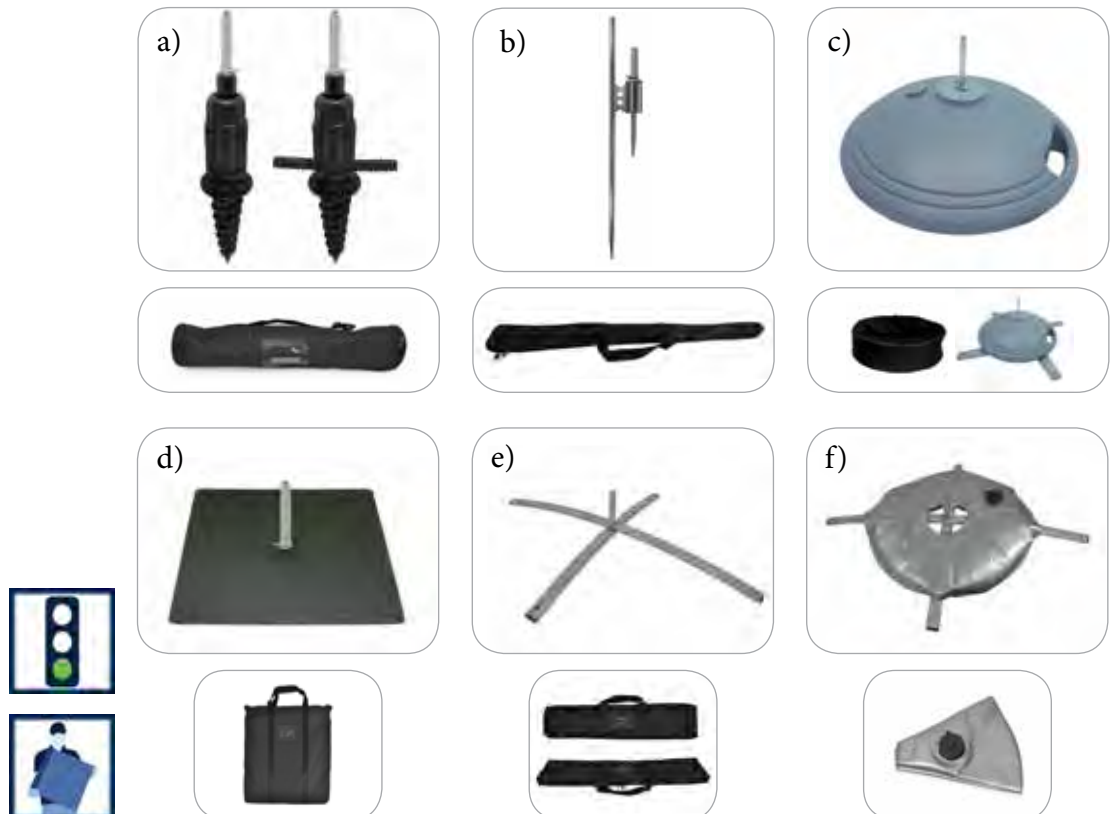

## Edelstahl-Bannerausleger | Stainless Steel Banner Wall-Bracket



Andere Versionen auf Anfrage.  
Other versions in on request.

- Exklusiver Wandausleger
  - Komplett aus Edelstahl
  - Das Banner wird mit der Konstruktion gespannt
  - Grafikproduktion, Wandversion und Beleuchtung auf Anfrage
- *Exclusive wall-bracket for banners*
  - *Made of stainless-steel*
  - *Banner is stretched by the construction*
  - *Graphic production, wall version and lamps on request*

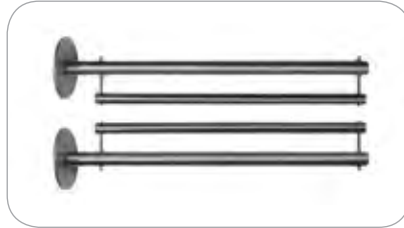

Art.-Nr.	Format (mm)
1800002	600 x 2500
1800003	800 x 3000

## NEU! InfoSign OUTDOOR | InfoSign OUTDOOR



- Freistehendes Rasenschild
  - Konstruktion aus verwindungssteifen L-Profilen aus Stahl, RAL 9005 schwarz pulverbeschichtet
  - Ideal als Immobilien, Willkommens, Warn, Werbe- oder Parkplatzschild
  - Bedruckte PVC Schaum- oder Alu- Verbundplatten werden von hinten verschraubt
  - Ständer wird einfach mit der Spitze in die Erde gesteckt
- *Free-standing lawn sign*
  - *Construction made of torsion-resistant L-profiles made of steel, RAL 9005 powder-coated*
  - *Ideally suited as a real estate, welcome, warning, advertising or parking lot sign*
  - *Printed PVC foam or aluminum composite panels are screwed on from behind*
  - *The stand is simply stuck with the tip into the ground*

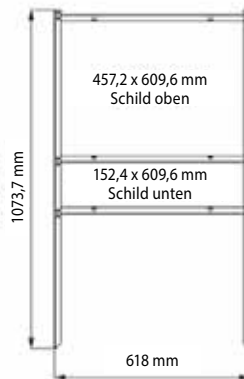
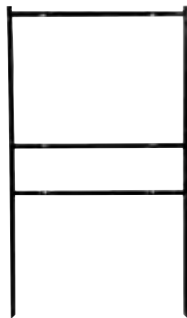

Andere Versionen auf Anfrage.  
Other versions in on request.

Art.-Nr.	Abmessung Schild oben (mm)	Abmessung Schild unten (mm)
URES80H124X2000	457,2 x 609,6	152,4 x 609,6

## MegaFrame | MegaFrame

- Bannerrahmen für XXL-Prints!
- Anwenderfreundliches Befestigungssystem
- Komponenten sind robust, langlebig, hochwertig und wiederverwendbar
- Banner kann ohne Werkzeug gewechselt werden
- Mehrere Rahmen können für ein größeres Visual aneinandergereiht werden

- *Banner frame for XXL prints!*
- *User-friendly fastening system*
- *Components are robust, durable, high quality and reusable*
- *Banner can be changed without tools*
- *Multiple frames can be used for a larger visual*



Art-Nr.	Ausführung	Bannermaß (mm)	Außenmaß (mm)
1808002	Wandrahmen	2000 x 2000	2200 x 2200
1808003	Wandrahmen	3000 x 4000	3200 x 4200
1808004	Wandrahmen	4000 x 6000	4200 x 6200
1808005	A-Aufsteller	2 x 2000 x 1000	2200 x 1200
1808006	Dreieck-Ständer	3 x 2000 x 1000	2200 x 1200
2807003	Beleuchtung	Wandmontage	

## Banner-Rohrrahmen | Banner Frame

- Bannerrahmen mit Expanderseil für XXL-Formate
- Geeignet für Wandmontage oder als Freiaufstellung
- Erhältlich in vielen Größen

- *Banner frame with expander for XXL formats*
- *Suitable for wall mounting or as free-standing version*
- *Available in many sizes*

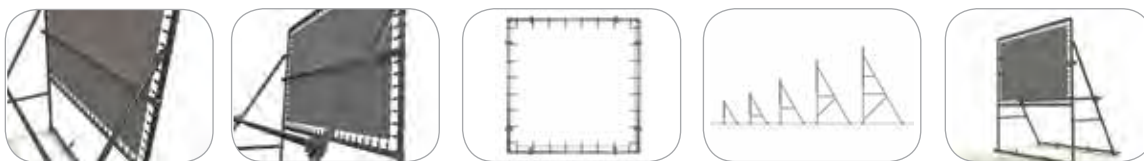

Art-Nr.	Ausführung	Bannermaß (mm)	Außenmaß (mm)
1803003	Wandrahmen	2000 x 2000	2260 x 2260
1803004	Wandrahmen	3000 x 4000	3260 x 4260
1803005	Wandrahmen	4000 x 6000	4260 x 6260
2807001	Beleuchtung	Ø 42 mm Rahmen	
2807002	Beleuchtung	Ø 48 mm Rahmen	



# Klapprahmen Opti Frame | Snap Frames Opti Frame

## Opti Frame Farbige | Opti Frame Colour

- Der patentierte Klapprahmen!
- Mit integrierter Rückenstütze
- Erhältlich in DIN A6 bis DIN A4
- Fünf Standardfarben

- *The patented snap frame!*
- *Integrated rear support*
- *Available in DIN A6 to DIN A4*
- *Five standard colors*



Art.-Nr.	Ausführung (mit Rückenstütze)	Format (DIN)
UCP145R1A6X1000	14 mm Gehrung, rot RAL 3020	A6
UCP145L1A6X1000	14 mm Gehrung, blau RAL 5002	A6
UCP145H1A6X1000	14 mm Gehrung, weiß RAL 9003	A6
UCP145E1A6X1000	14 mm Gehrung, grün RAL 6029	A6
UCP145Y1A6X2000	14 mm Gehrung, gelb RAL 1021	A6
UCP145R1A5X2000	14 mm Gehrung, rot RAL 3020	A5
UCP145L1A5X1000	14 mm Gehrung, blau RAL 5002	A5
UCP145H1A5X2000	14 mm Gehrung, weiß RAL 9003	A5
UCP145E1A5X1000	14 mm Gehrung, grün RAL 6029	A5
UCP145Y1A5X2000	14 mm Gehrung, gelb RAL 1021	A5
UCP145R1A4X1000	14 mm Gehrung, rot RAL 3020	A4
UCP145L1A4X1000	14 mm Gehrung, blau RAL 5002	A4
UCP145H1A4X1000	14 mm Gehrung, weiß RAL 9003	A4
UCP145E1A4X1000	14 mm Gehrung, grün RAL 6029	A4
UCP145Y1A4X1000	14 mm Gehrung, gelb RAL 1021	A4

Opti®  
Frame

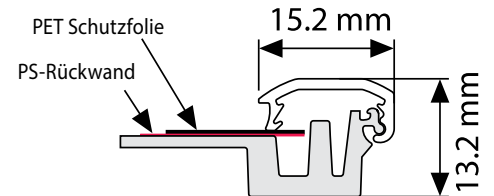

## Opti Frame Schwarz/Holz | Opti Frame Black/Wood Effect

- 25 mm / Gehrung – Schwarz/Holz Optik
- Der patentierte Klapprahmen!
- Schwarz pulverbeschichtet oder in Holz-Optik
- Farblich abgestimmte Rückwand

- *25 mm / Mitred – Black/Wood Effect*
- *The patented snap frame!*
- *Powder-coated in black or wood finish*
- *Color coordinated backing*

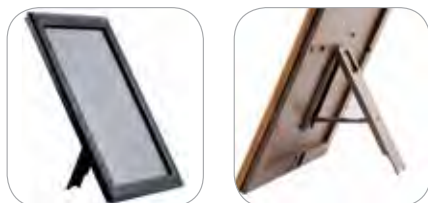

Opti®  
Frame

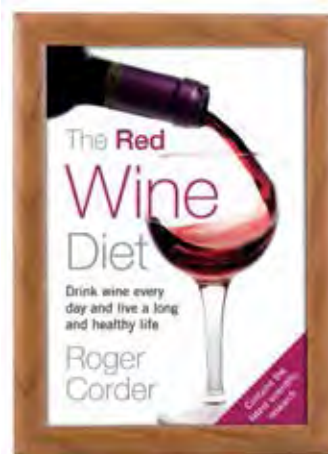

Art.-Nr.	Plakatmaß (mm)	Farbe	Beschreibung
UCP255B1A4X1000	210 x 297	schwarz	mit Rückenstütze
UCP255B0A4X1000	210 x 297	schwarz	ohne Rückenstütze
UCP255W1A4X1000	210 x 297	Holz-Optik	mit Rückenstütze
UCP255W0A4X1000	210 x 297	Holz-Optik	ohne Rückenstütze

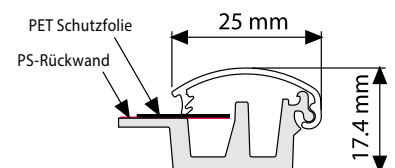

# Klapprahmen Opti Frame/Basic Frame | Snap Frames Opti Frame/Basic Frame

## Magnet Posterrahmen | Magnetic Poster Frame

### Opti Frame/Basic Frame | Opti Frame/Basic Frame

- 25 mm / Gehrung – Rondo
- Patentierter Klapprahmen!
- Mit Rückenstütze nutzbar als Fotorahmen
- Safe Corner Ecke
- Basic Frame als Economy Version in 10 er Karton

- 25 mm / Mitred – Rounded
- Patented snap frame!
- With rear support for desktop application
- Safe corner version
- Basic Frame as economy version packed by 10 pcs

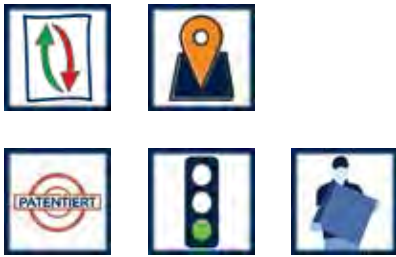
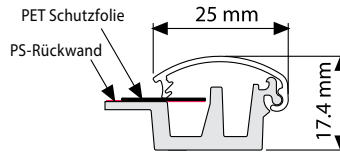

Opti Frame



Basic Frame



Art.-Nr. Gehrung	Art.-Nr. Rondo	Plakatmaß (mm)	Beschreibung
UCB255N0A4X2000	-	210 x 297	Basic Frame
UCP255N0A4X1000	UCP250N0A4X1000	210 x 297	ohne Rückenstütze
UCP255N1A4X1000	UCP250N1A4X1000	210 x 297	mit Rückenstütze
UCP255N0A3X1000	UCP250N0A3X1000	297 x 420	ohne Rückenstütze
UCP255N0A2X1000	UCP250N0A2X1000	420 x 594	ohne Rückenstütze
UCP255N0A1X2950	UCP250N0A1X2950	594 x 841	ohne Rückenstütze
UCP255N0B2X1000	UCP250N0B2X1000	500 x 700	ohne Rückenstütze

Opti®  
Frame

### Magnet Posterrahmen | Magnetic Poster Frame

- Elegante Alternative zum klassischen Klapprahmen!
- Moderner TFT-Look
- Einseitige Version nur 12 mm Bautiefe, doppelseitige Version 19 mm Bautiefe
- Motiv wird mit Magnettechnik hinter der Schutzfolie gehalten
- Erhältlich in ein- und doppelseitiger Ausführung

- Stylish alternative to the classic snapframe
- Modern flat screen-look
- Single sided version only 12 mm depth, double sided version 19 mm depth
- Motive is hold behind the protective film by magnetic cover
- Available in single and double sided design



Art.-Nr.	Ausführung	Plakatmaß (mm)	Passepartout
UCMONTB0A4X2000	einseitig	210 x 297	schwarz
UCMONTB0A3X2000	einseitig	297 x 420	schwarz
UCMONTB0A2X2000	einseitig	420 x 594	schwarz
UCMONTB0A1X2950	einseitig	594 x 841	schwarz
UCMONTB0A0X2950	einseitig	841 x 1189	schwarz
UCMONTB0B2X2000	einseitig	500 x 700	schwarz
UCMONTB0B1X2000	einseitig	700 x 1000	schwarz
UCMONCB0A4X2000	doppelseitig	210 x 297	schwarz
UCMONCB0A3X2000	doppelseitig	297 x 420	schwarz
UCMONCB0A2X2000	doppelseitig	420 x 594	schwarz
UCMONCB0A1X2950	doppelseitig	594 x 841	schwarz
UCMONCB0A0X2950	doppelseitig	841 x 1189	schwarz
UCMONCB0B2X2000	doppelseitig	500 x 700	schwarz
UCMONCB0B1X2000	doppelseitig	700 x 1000	schwarz



## Klapprahmen 15/20/25/32 mm | Snap Frame 15/20/25/32 mm

- Ideal für alle Posterformate!
- Oberprofile silber eloxiert
- Rückwand aus Polystyrol
- Vordere Plakatabdeckung aus entspiegeltem PET
- Sondermaße und RAL Farben auf Anfrage

- *Ideal for all poster sizes!*
- *Top profiles silver anodised*
- *Backing made of polystyrene*
- *Front poster cover made of non-reflective PET*
- *Special dimensions and RAL colors on request*



15 mm Klapprahmen, Gehrung  
15 mm Snap frame, mitred

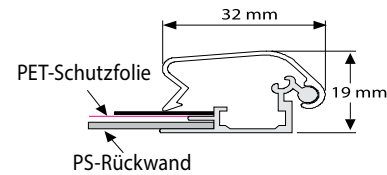
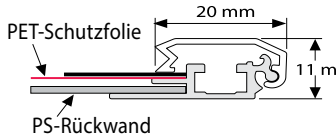
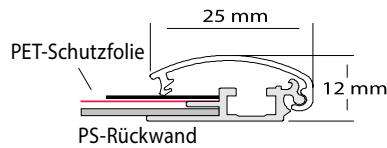
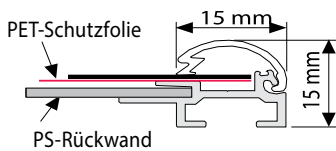

Version Rondo  
Rounded version



20 mm Klapprahmen, Gehrung  
20 mm Snap frame, mitred

Art.-Nr. Gehrung	Art.-Nr. Rondo	Profil (mm)	Plakatmaß (mm)
UCN155NOA5X1000	-	15	148 x 210
UCN155NOA4X1000	-	15	210 x 297
UCN155NOA3X1000	-	15	297 x 420
UCN155NOA2X1000	-	15	420 x 594
UCN155NOA1X2950	-	15	594 x 841
UCN155NOB2X1000	-	15	500 x 700
UCN155NOB1X1000	-	15	700 x 1000
UCN205NOA4X1000	-	20	210 x 297
UCN205NOA3X1000	-	20	297 x 420
UCN205NOA2X1000	-	20	420 x 594
UCN205NOA1X2950	-	20	594 x 841
UCN205NOB2X1000	-	20	500 x 700
UCN205NOB1X1000	-	20	700 x 1000
UCN255NOA4X1000	UCN250NOA4X1000	25	210 x 297
UCN255NOA3X1000	UCN250NOA3X1000	25	297 x 420
UCN255NOA2X1000	UCN250NOA2X1000	25	420 x 594
UCN255NOA1X2950	UCN250NOA1X2950	25	594 x 841
UCN255NOA0X2950	UCN250NOA0X2950	25	841 x 1189
UCN255NOB2X1000	UCN250NOB2X1000	25	500 x 700
UCN255NOB1X1000	UCN250NOB1X1000	25	700 x 1000
UCN325NOA2X1000	UCN320NOA2X1000	32	420 x 594
UCN325NOA1X2950	UCN320NOA1X2950	32	594 x 841
UCN325NOA0X2950	UCN320NOA0X2950	32	841 x 1189
UCN325NOB2X1000	UCN320NOB2X1000	32	500 x 700
UCN325NOB1X1000	UCN320NOB1X1000	32	700 x 1000
UCN325NOB0X1000	UCN320NOB0X1000	32	1000 x 1400



32 mm Klapprahmen, Gehrung  
32 mm Snap frame, mitred



25 mm Klapprahmen, Gehrung  
25 mm Snap frame, mitred



## Klapprahmen 25mm Schwarz, Edelstahl-, Holz-, Goldoptik oder RAL |

Snap Frame 25 mm black powder-coated, Stainless Steel Look, Wood Look Effect, Gold Look or RAL

- Exklusiver Rahmen in unterschiedlicher Farbgestaltung
- Ecken auf Gehrung
- Ideal für Posterformat DIN A4 bis DIN A0
- Sondermaße auf Anfrage

- The bestseller with various finishes
- Mitred corners
- Ideal for postersize DIN A4 to DIN A0
- Special dimensions on request

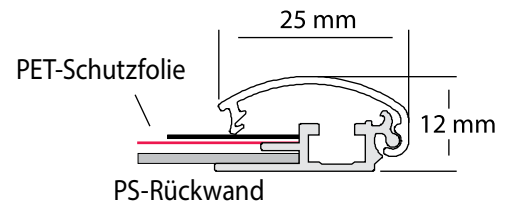

Holz-Optik / Wood effect



Holz-Optik hell / Light wood effect



RAL 9005 schwarz / RAL 9005 black



Gold-Optik / Gold look



Edelstahl-Optik / Stainless-steel look



RAL 9003

RAL 5002



RAL 3020



Art.-Nr.	Farbe	Plakatmaß (mm)
UCN255S0A4X1000	Edelstahl Optik	210 x 297
UCN255S0A3X1000	Edelstahl Optik	297 x 420
UCN255S0A2X1000	Edelstahl Optik	420 x 594
UCN255S0A1X2950	Edelstahl Optik	594 x 841
UCN255S0A0X2950	Edelstahl Optik	841 x 1189
UCN255S0B2X1000	Edelstahl Optik	500 x 700
UCN255S0B1X1000	Edelstahl Optik	700 x 1000
UCN25510A4X2000	schwarz   RAL 9005	210 x 297
UCN25510A3X2000	schwarz   RAL 9005	297 x 420
UCN25510A2X2000	schwarz   RAL 9005	420 x 594
UCN25510A1X2950	schwarz   RAL 9005	594 x 841
UCN25510A0X2950	schwarz   RAL 9005	841 x 1189
UCN25510B2X2000	schwarz   RAL 9005	500 x 700
UCN25510B1X2000	schwarz   RAL 9005	700 x 1000
UCN255W0A4X1000	Holz Optik	210 x 297
UCN255W0A3X1000	Holz Optik	297 x 420
UCN255W0A2X1000	Holz Optik	420 x 594
UCN255W0A1X2950	Holz Optik	594 x 841
UCN255W0A0X2950	Holz Optik	841 x 1189
UCN255W0B2X1000	Holz Optik	500 x 700
UCN255W0B1X1000	Holz Optik	700 x 1000
UCN255W1A4X2000	Holz Optik hell	210 x 297
UCN255W1A3X2000	Holz Optik hell	297 x 420
UCN255W1A2X2000	Holz Optik hell	420 x 594
UCN255W1A1X2950	Holz Optik hell	594 x 841
UCN255W1A0X2950	Holz Optik hell	841 x 1189
UCN255W1B2X2000	Holz Optik hell	500 x 700
UCN255W1B1X2000	Holz Optik hell	700 x 1000
UCN255G0A4X1000	Gold Optik	210 x 297
UCN255G0A3X1000	Gold Optik	297 x 420
UCN255G0A2X1000	Gold Optik	420 x 594
UCN255G0A1X2950	Gold Optik	594 x 841
UCN255G0A0X2950	Gold Optik	841 x 1189
UCN255G0B2X1000	Gold Optik	500 x 700
UCN255G0B1X1000	Gold Optik	700 x 1000
UCN25520A4X2000	weiß   RAL 9003	210 x 297
UCN25520A3X2000	weiß   RAL 9003	297 x 420
UCN25520A2X2000	weiß   RAL 9003	420 x 594
UCN25520A1X2950	weiß   RAL 9003	594 x 841
UCN25520A0X2950	weiß   RAL 9003	841 x 1189
UCN25520B2X2000	weiß   RAL 9003	500 x 700
UCN25520B1X2000	weiß   RAL 9003	700 x 1000
UCN255COA4X5024	blau   RAL 5002	210 x 297
UCN255COA3X5024	blau   RAL 5002	297 x 420
UCN255COA2X5141	blau   RAL 5002	420 x 594
UCN255COA1X5114	blau   RAL 5002	594 x 841
UCN255COA0X5020	blau   RAL 5002	841 x 1189
UCN255COB2X5037	blau   RAL 5002	500 x 700
UCN255COB1X5043	blau   RAL 5002	700 x 1000
UCN25530A4X2000	rot   RAL 3020	210 x 297
UCN25530A3X2000	rot   RAL 3020	297 x 420
UCN25530A2X2000	rot   RAL 3020	420 x 594
UCN25530A1X2950	rot   RAL 3020	594 x 841
UCN25530A0X2950	rot   RAL 3020	841 x 1189
UCN25530B2X2000	rot   RAL 3020	500 x 700
UCN25530B1X2000	rot   RAL 3020	700 x 1000

## Klapprahmen FireProtection | Snap Frame FireProtection

- Klapprahmen für den Einsatz in öffentlichen Räumen
- Schutzfolie aus B1 zertifiziertem PET
- Rahmen mit Zertifikat
- Sondermaße auf Anfrage
- *Snapframe for public buildings*
- *Cover sheet with B1 certification*
- *Metal backing*
- *Special dimensions on request*



Art.-Nr.	Plakatmaß (mm)	Farbe
UCFR255NA4X2000	210 x 297	silber eloxiert
UCFR255NA3X2000	297 x 420	silber eloxiert
UCFR255NA2X2000	420 x 594	silber eloxiert
UCFR255NA1X2950	594 x 841	silber eloxiert
UCFR255NA0X2950	841 x 1189	silber eloxiert
UCFR255NB2X2000	500 x 700	silber eloxiert
UCFR255NB1X2000	700 x 1000	silber eloxiert
UCFR255BA4X2000	210 x 297	schwarz eloxiert
UCFR255BA3X2000	297 x 420	schwarz eloxiert
UCFR255BA2X2000	420 x 594	schwarz eloxiert
UCFR255BA1X2950	594 x 841	schwarz eloxiert
UCFR255BA0X2950	841 x 1189	schwarz eloxiert
UCFR255BB2X2000	500 x 700	schwarz eloxiert
UCFR255BB1X2000	700 x 1000	schwarz eloxiert

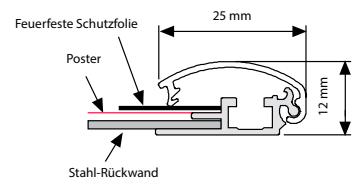

## Doppelseitiger Klapprahmen | Double-sided Snap Frame

- 25 mm Profil / Gehrung
- Ideal für Schaufensterwerbung oder Ladengestaltung
- Ecken auf Gehrung
- Nutzbar im Hoch- oder Querformat mit 2 Ringschrauben
- **(Standard Ausführung im Hochformat, Ausführung im Querformat auf Bestellung)**
- Deckenabhängige-Set als Zubehör erhältlich
- *25 mm Profile / Mitred*
- *Ideal for shop window or store*
- *Mitred corners*
- *Can be uses portrait or landscape with 2 hooks*
- **(Standard version in portrait format, version in landscape format to order)**
- *Ceiling suspension set must be ordered separately*



Art.-Nr.	Plakatmaß (mm)
UCD255N2A4X1000	210 x 297
UCD255N2A3X1000	297 x 420
UCD255N2A2X1000	420 x 594
UCD255N2A1X1000	594 x 841
UCD255N2A0X1000	841 x 1189
UCD255N2B2X1000	500 x 700
UCD255N2B1X1000	700 x 1000
Art.-Nr.	Beschreibung
2100005	Seilset

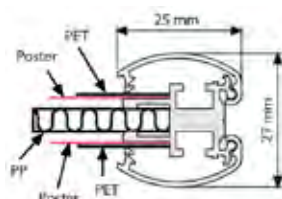

Artikel-Nr.: 2100005



**Safety-Klapprahmen** | Security Frame

- 25 mm Profil / Gehrung Safety
  - Sicherheitsprofil ohne Griffmulde
  - Spezialhebel für Profillöpfung erforderlich
  - Ideal für öffentliche Räume
  - Profillöffner als Zubehör erhältlich
- 25 mm Profile / Mitred Security
  - Suitable for public areas
  - Snap profile without grip
  - Frame can be opened with lever tool
  - Lever tool must be ordered separately

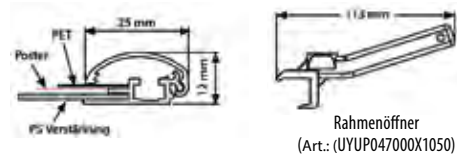

Art.-Nr.	Plakatmaß (mm)
UCZ255N0A4X1000	210 x 297
UCZ255N0A3X1000	297 x 420
UCZ255N0A2X1000	420 x 594
UCZ255N0A1X1000	594 x 841
UCZ255N0B2X1000	500 x 700
Art.-Nr.	Bezeichnung
UYUP047000X1050	Rahmenöffner 25/32

**Klapprahmen HardLine, 33 mm, Gehrung, schwarz** | Snap Frame HardLine, 33 mm, mitred, black

- Neuer Design Klapprahmen in kantiger Optik
  - Schwarze Klemmprofile
  - Klares, flaches Profildesign
  - Ideal geeignet bis Posterformat DIN A0
- New design Snap frame in an edgy look
  - Black clamping profiles
  - Clear, flat look
  - Ideally suited to poster size DIN A0

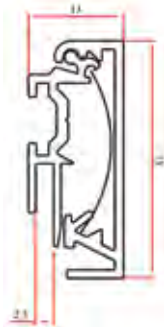

Art.-Nr.	Plakatmaß (mm)
UCN335COA4X5003	210 x 297
UCN335COA3X5008	297 x 420
UCN335COA2X5001	420 x 594
UCN335COA1X5001	594 x 841
UCN335COA0X5001	841 x 1189
UCN335COB2X5005	500 x 700
UCN335COB1X5001	700 x 1000

## Wasserfester Klapprahmen | Waterproof Snap Frame

- Perfekt für den Außeneinsatz
- 25 mm Profil
- Ecken auf Gehrung
- Umlaufende Dichtung auf dem Unterprofil
- Übergroße Schutzfolie
- Wasserablauföffnungen verhindern Staunässe
- *Perfect for outdoor use*
- *25 mm Profile*
- *Mitred corners*
- *Sealing on backprofile*
- *Oversize cover sheet*
- *Water drainage holes avoid moisture*



Art.-Nr.	Plakatmaß (mm)	Farbe
UCH255NOA4X1000	210 x 297	silber
UCH255NOA3X1000	297 x 420	silber
UCH255NOA2X1000	420 x 594	silber
UCH255NOA1X2950	594 x 841	silber
UCH255NOA0X2950	841 x 1189	silber
UCH255NOB2X1000	500 x 700	silber
UCH255NOB1X1000	700 x 1000	silber
UCH255COA4X5001	210 x 297	schwarz
UCH255COA3X5011	297 x 420	schwarz
UCH255COA2X5000	420 x 594	schwarz
UCH255COA1X5003	594 x 841	schwarz
UCH255COA0X5002	841 x 1189	schwarz
UCH255COB2X5006	500 x 700	schwarz
UCH255COB1X5001	700 x 1000	schwarz

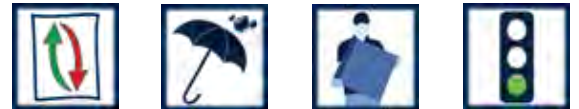
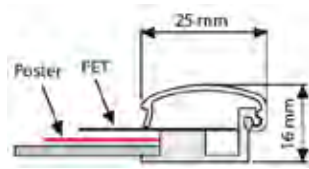

## Wasserfester Klapprahmen mit Sicherungsschraube | Lockable Waterproof Snap Frame

- 35 mm Profil / Gehrung
- Geeignet für Außeneinsatz
- Sicherung des Rahmens durch Inbusschraube und Metallecken
- Umlaufende Dichtung auf dem Unterprofil
- Übergroße Schutzfolie
- Wasserablauföffnungen verhindern Staunässe
- *35 mm Profile / Mitred*
- *Suitable for outdoor use*
- *Profiles open sequentially*
- *Last profile is secured by allen screw*
- *Sealing on backprofile*
- *Oversize cover sheet*
- *Water drainage holes avoid moisture*

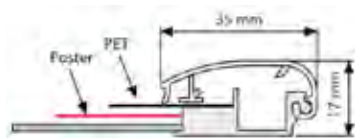

Art.-Nr.	Plakatmaß (mm)
UCV355NOA3X1000	297 x 420
UCV355NOA2X1000	420 x 594
UCV355NOA1X2950	594 x 841
UCV355NOA0X2950	841 x 1189
UCV355NOB2X1000	500 x 700
UCV355NOB1X1000	700 x 1000
UCV355NOBOX1000	1000 x 1400



## Fenster-Klapprahmen | Window Frame

- 25 mm Profil / Gehung
- Poster sind auf beiden Seiten des Schaufensters sichtbar
- Mit Spiegelklebeband konfektioniert für die Montage auf Glas
- Plakatwechsel erfolgt von innen
- Konterrahmen als Blende für Außen

- 25 mm Profile / Mitred
- Posters are visible in – and outdoor
- Comes with double sided tape
- Poster change indoor
- Decorative cover frame for outdoor



Art.-Nr.	Plakatmaß (mm)
UCW255N4A4X1000	210 x 297
UCW255N4A3X1000	297 x 420
UCW255N4A2X1000	420 x 594
UCW255N4A1X2950	594 x 841
UCW255N4B2X1000	500 x 700
UCW255N4B1X1000	700 x 1000

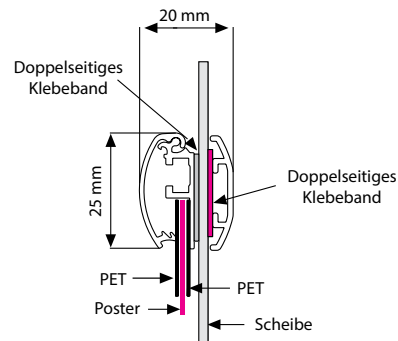

## NEU! Fensterklapprahmen, 33 mm HardLine | Window Frame 33 mm HardLine

- Ideal für größere Formate
- Modernes, kantiges Profildesign, RAL 9005
- Poster sind auf beiden Seiten des Schaufensters sichtbar
- Schwarzes Acrylat-Klebeband erzeugt einen Rahmen-Look auch auf der Außenseite des Fensters
- OHNE Konterrahmen

- Ideal for large poster sizes
- Modern, square profile design, RAL 9005
- Posters are visible on both sides of the shop window
- Black acrylic tape creates a frame look on the outside of the window
- Comes WITHOUT counter frame



Art.-Nr.	Farbe	Plakatmaß (mm)
UCW335C4A1X5001	RAL 9005 schwarz	594 x 841
UCW335C4B1X5000	RAL 9005 schwarz	700 x 1000
UCW335C4A0X5000	RAL 9005 schwarz	841 x 1189



## Easy-Fix Klapprahmen | Double sided tape snapframe



- 25 mm Profil / Gehrung
  - Ideal für alle glatten Flächen - auspacken, ankleben - Plakat einlegen - fertig!
  - Sekundenschnelle Montage ohne Werkzeug
  - Sicherer Halt dank hochwertigem Spiegel-Klebeband
- 25 mm Profile / Mitred
  - Ideal for all even surfaces
  - Easy and toolless fixation
  - Secure attachment thanks to rear double sided tape

Art.-Nr.	Plakatmaß (mm)	Farbe
UCN255N0A4X5038	210 x 297	silber
UCN255N0A3X5076	297 x 420	silber
UCN255N0A2X5047	420 x 594	silber
UCN255N0A1X5042	594 x 841	silber
UCN255N0A0X5626	841 x 1189	silber
UCN255N0B2X5022	500 x 700	silber
UCN255N0B1X5017	700 x 1000	silber
UCN255COA4X5078	210 x 297	schwarz
UCN255COA3X5178	297 x 420	schwarz
UCN255COA2X5109	420 x 594	schwarz
UCN255COA1X5142	594 x 841	schwarz
UCN255COA0X5032	841 x 1189	schwarz
UCN255COB2X5079	500 x 700	schwarz
UCN255COB1X5045	700 x 1000	schwarz



## NEU! Klapprahmen MAXI, 35 mm | Snap Frame MAXI, 35 mm

- Der Alleskönner
- Textil-Spannrahmen und Alu-Klapprahmen in einem Produkt
- 36 mm Klapprahmen mit Außennut
- Polystyrol Rückwand
- Entspiegelte PVC Schutzfolie
- Zweifarbige Ausführung möglich

- The all-rounder
- Textile stretch-frame and aluminium snap frame in one product
- 36 mm aluminium clip-profile with lateral groove
- Polystyrene backing
- Anti-reflective PVC cover sheet
- Duo color version optional



Art.-Nr.	Plakatmaß (mm)	Farbe
1770010	210 x 297	silber
1770011	297 x 420	silber
1770012	420 x 594	silber
1770013	594 x 841	silber
1770014	841 x 1189	silber
1770016	500 x 700	silber
1770015	700 x 1000	silber



## Doppelseitiger Einschubrahmen | Double-sided Slide-in Frame

- Doppelseitiger Poster-Rahmen mit seitlichem Einschub
- Verschiebbare Aufhänger oben
- Plakatabdeckung durch 2 PET Folien
- Seil-Abhänge Set als optionales Zubehör
- *Double sided poster frame with lateral insertion*
- *Moveable hooks on top*
- *Poster protection by 2 PET sheets*
- *Ceiling suspension-set needs to be ordered separately*



Art.-Nr. Hochformat	Art.-Nr. Querformat	Plakatmaß (mm)
UCS255N1A4X1000	UCS255N2A4X1000	210 x 297
UCS255N1A3X1000	UCS255N2A3X1000	297 x 420
UCS255N1A2X1000	UCS255N2A2X1000	420 x 594
UCS255N1A1X1000	UCS255N2A1X1000	594 x 841
UCS255N1B2X1000	UCS255N2B2X1000	500 x 700
Art.-Nr.	Beschreibung	
2100001	Drahtseil- Abhängeset	

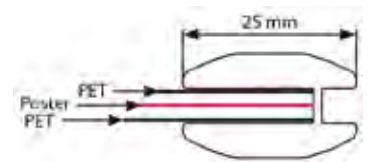

## Einschubrahmen als Info-Topper | Counter Slide-in Frame

- Desktop Posterrahmen für In- und Outdoor
- Einfache Montage von Standfuß durch doppelseitiges Klebeband
- Wetterfest durch Dichtgummi auf der Einschubseite
- Ideal geeignet für den Einsatz auf Zapfsäulen, Theken oder Regalen
- *Desktop poster frame for in- and outdoor use*
- *Easy mounting thanks to feet with double-sided tape*
- *Weatherproof thanks to sealing at slide-in opening*
- *Ideally suited for application on pumps, counters or shelves*

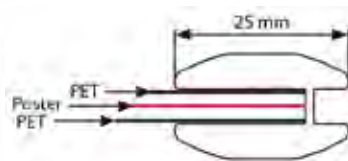

Art.-Nr.	Plakatmaß (mm)
UCA255N2A4X1000	210 x 297
UCA255N2A3X1000	297 x 420

## Spannrahmen | Stretch Frame

- Federleichter Poster-Rahmen
  - Filigranes Aluminium Profil mit steckbaren Eckverbindern
  - Verschiebbare Aufhänger erlauben Hoch- oder Querformat
  - Plakatklammern mit extra breiter Auflagefläche verhindern Ausreißen der Plakate
- *Lightweight poster frame*
  - *Filigree aluminum profile with plug-in corner connectors*
  - *Moveable hooks allow portrait or landscape application*
  - *Poster clamps with extra wide surface prevent the posters from tearing out*

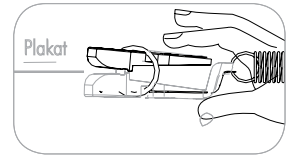

Art.-Nr.	Plakatmaß (mm)
UPSCN000A4X5008	210 x 297
UPSCN000A3X5004	297 x 420
UPSCN000A2X5002	420 x 594
UPSCN000A1X5005	594 x 841
UPSCN000B2X5005	500 x 700
UPSCN000B1X5002	700 x 1000
Art.-Nr.	Beschreibung
2100039	Nylon-Seilset

## Poster-Klemmleiste Fast | Poster Fast

- Alu- Abhängeschiene
  - Set aus 2 Schienen
  - Verschiebbare Aufhänger an oberer Schiene
  - 40 mm Einschub Plastik-Klemmen für Poster, Banner oder Preisschilder
- *Aluminium suspension-rail*
  - *Set of 2 rails*
  - *Moveable hooks on top-rail*
  - *Inserted 40 mm grippers for poster, banner or price labels*



Art.-Nr.	Plakatmaß (mm)
UPF21SN021X1000	210
UPF21SN030X1000	300
UPF21SN042X1000	420
UPF21SN050X1000	500
UPF21SN060X1000	600
UPF21SN070X1000	700
UPF21SN085X1000	841
UPF21SN100X1000	1000
UPF21SN120X1000	1200
Art.-Nr.	Beschreibung
2100001	Drahtseil- Abhängeset

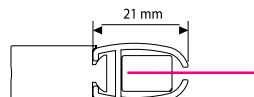

## Poster-Klemmleiste Clamp | Poster Clamp

- Ideale Lösung für große Banner
  - Set bestehend aus 2 Klemmleisten
  - Verschiebbare Aufhänger an der oberen Leiste
  - Hohe Klemmwirkung durch Exzenter-Prinzip
- *Ideal solution for large banner advertising*
  - *Set of 2 clamp-rails*
  - *Moveable hooks on top-rail*
  - *High grip thanks to eccentric clamp*



Art.-Nr.	Länge (mm)
UPC00SN021X1000	210
UPC00SN030X1000	300
UPC00SN042X1000	420
UPC00SN050X1000	500
UPC00SN060X1000	600
UPC00SN070X1000	700
UPC00SN085X1000	841
UPC00SN100X1000	1000
Art.-Nr.	Beschreibung
2100001	Drahtseil- Abhängeset

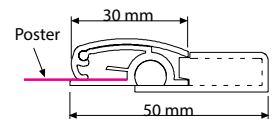



## Poster-Klemmleiste Snap | Poster Snap

- Die preiswerte Lösung für die Plakat- oder Bannerwerbung
  - Set bestehend aus 2 Klemmleisten
  - Verschiebbare Aufhänger an der oberen Leiste
  - Eingeklebtes Anti-Rutsch Gummi
- *Competitive solution for poster or banner advertising*
  - *Set of 2 snap-rails*
  - *Moveable hooks on top-rail*
  - *Poster clamps with extra wide surface prevent the posters from tearing out*

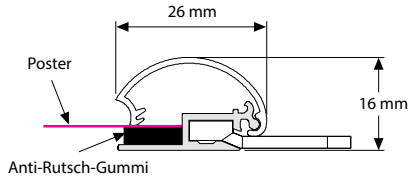

Art.-Nr.	Länge (mm)	Farbe	Beschreibung
UPT26SN030X1000	300	silbern eloxiert	26 mm Profil, Set
UPT26SN042X1000	420	silbern eloxiert	26 mm Profil, Set
UPT26SN050X1000	500	silbern eloxiert	26 mm Profil, Set
UPT26SN060X1000	600	silbern eloxiert	26 mm Profil, Set
UPT26SN070X1000	700	silbern eloxiert	26 mm Profil, Set
UPT26SN085X1000	850	silbern eloxiert	26 mm Profil, Set
UPT26SN100X1000	1000	silbern eloxiert	26 mm Profil, Set
Art.-Nr.	Beschreibung		
2100001	Drahtseil- Abhänageset		

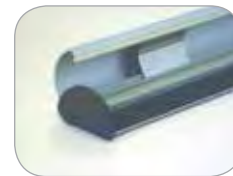
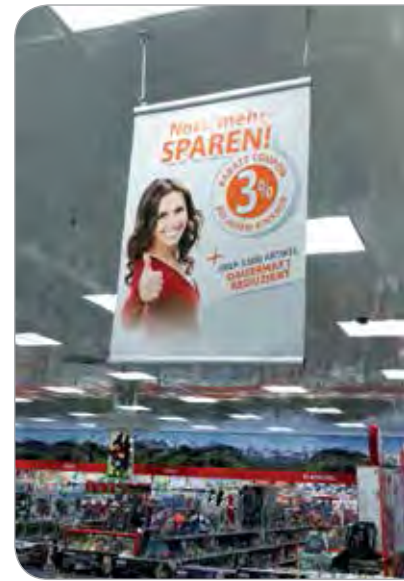

## NEU! Poster Klemmleiste WOOD | Poster Snap WOOD

- Stilvolle Poster-Präsentation bestehend aus zwei Leisten aus massivem Buchenholz, dunkel lasiert
  - Feste Klemmung durch eingesenkte Power-Magnete
  - Einfache Aufhängung dank mitgelieferter Hanf Schnur
- *Stylish poster presentation consisting of two rails of solid beech wood, dark lacquered*
  - *Strong clamping through recessed power magnets*
  - *Easy hanging thanks to the included natural rope*

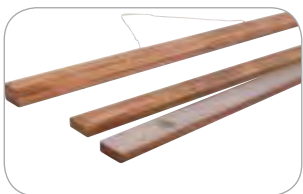
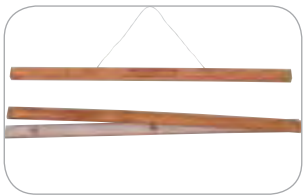

Art.-Nr.	Farbe	Länge (mm)
UPTW0SD300X2000	Buche, dunkel	300
UPTW0SD400X2000	Buche, dunkel	400
UPTW0SD500X2000	Buche, dunkel	500
UPTW0SD600X2000	Buche, dunkel	600



## Gewölbter Infoständer | Curved Menuboard

- Eleganter Infoständer mit gewölbtem Zentralprofil
- Klapprahmen kann im Hoch- und im Querformat genutzt werden
- Stabile Bodenplatte
- Erhältliche Farben: Silber, Schwarz, Kupfer, Perlweiß, Pale Rose, Erdfarben
- Stylish Menuboard with curved leg
- Snapframe can be used portrait or landscape position
- Stable base plate
- Available colors: silver, black, copper, pearl white, pale rose, earth colors



Art.-Nr.	Ausführung	Farbe	Höhe max. (mm)	Höhe min. (mm)	Plakatmaß (mm)
UCUMBB05A4X1000	Gehrung	Schwarz/Black	1215	1180	210 x 297
UCUMBB05A3X1000	Gehrung	Schwarz/Black	1265	1212	297 x 420
UCUMBN05A4X1000	Gehrung	Silber/Silver	1215	1180	210 x 297
UCUMBN05A3X1000	Gehrung	Silber/Silver	1265	1212	297 x 420
UCUMBN00A4X1000	Rondo	Silber/Silver	1215	1180	210 x 297
UCUMBN00A3X1000	Rondo	Silber/Silver	1265	1212	297 x 420
UCUMB105A4X2000	Gehrung	Kupferfarben	1215	1180	210 x 297
UCUMB205A4X2000	Gehrung	Perlweiss	1215	1180	210 x 297
UCUMB305A4X2000	Gehrung	Erdfarben	1215	1180	210 x 297
UCUMB405A4X2000	Gehrung	Pale Rose	1215	1180	210 x 297

**Infoständer Konkav** | *Arc Menuboard*

- Stilvoller Infoständer im geschwungenen Design
- Elegante Präsentation von Speisekarten oder Informationen
- Standfestes Gestell aus pulverbeschichtetem Stahl
- Einfacher Wechsel der Einleger durch Magnetfolie

- *Stylish menuboard with curved design*
- *Elegant presentation of information*
- *Stable base and upright made of powder-coated steel*
- *Easy change of graphic by magnetic poster cover*

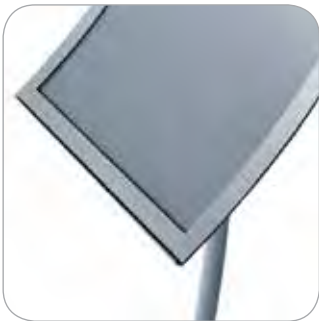
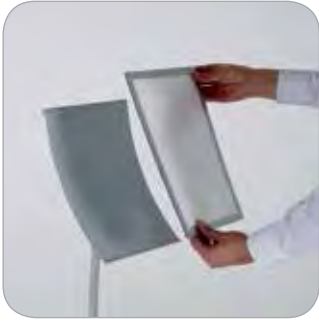

Art.-Nr.	Plakatmaß (mm)	Ausführung
UAMBOPOGA4X2000	210 x 297	silber
UAMBOPOGA3X2000	297 x 420	silber
UAMBOPOBA4X2000	210 x 297	schwarz
UAMBOPOBA3X2000	297 x 420	schwarz

## Dekorativer Infoständer | Decorative Menuboard



- Infoständer mit dekorativer, schwerer Bodenplatte für festen Stand
- Klapprahmen kann im Hoch- und im Querformat genutzt werden
- Ovale Zentralprofil
- Ecken: Rondo oder Gehrung
- Farben: Schwarz und silber

- *Menuboard with decorative, heavy base plate for a firm stand*
- *Snapframe can be used portrait or landscape*
- *Elliptic central upright*
- *Rounded or Mitred Corners*
- *Black or silver Color*

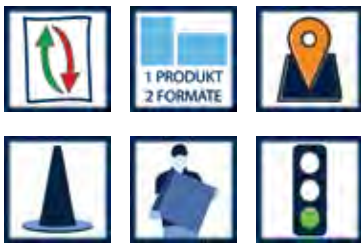

Art.-Nr. Gehrung	Art.-Nr. Rondo	Plakatmaß (mm)	Farbe
UDMB1N05A4X1000	UDMB1N00A4X2000	210 x 297	silber
UDMB1N05A3X1000	UDMB1N00A3X1000	297 x 420	silber
UDMB1N05A2X2000	UDMB1N00A2X2000	420 x 594	silber
UDMB1B05A4X2000	UDMB1B00A4X2000	210 x 297	schwarz
UDMB1B05A3X2000	UDMB1B00A3X2000	297 x 420	schwarz
UDMB1B05A2X2000	UDMB1B00A2X2000	420 x 594	schwarz



## NEU! Infoständer SIGN | Menuboard SIGN



- Aufmerksamkeitsstarker Infoständer
- Stabile Stahl-Fußplatte
- Ovale Zentralprofil mit integrierter Systemnut
- Doppelseitiger Einschubrahmen im 25 mm Profil mit 6 mm Einschuböffnung
- Nutzbar im Hoch- oder Querformat
- PET-Schutzfolien mit Trennplatte
- Paketdienstfähige Einzelverpackung

- *Eye-catching information stand*
- *Stable steel base plate*
- *Oval central upright with integrated system groove*
- *Double-sided slide-in frame in 25 mm profile with 6 mm opening*
- *Can be used in portrait or landscape format*
- *PET protective films with intermediate separating plate*
- *Individual packaging suitable for parcel service*



Art.-Nr.	Farbe	Plakatmaß (mm)
UIBSHN00A2X2000	silber	420 x 594
UIBSHN00A1X2000	silber	594 x 841
UIBSHB00A2X2000	schwarz	420 x 594
UIBSHB00A1X2000	schwarz	594 x 841

**Infoständer Economy, einseitig** | *Economy Menuboard, single sided*

- **Der preisgünstige Alleskönner!**
- In der Höhe und im Format einstellbar
- Stabile, runde Bodenplatte aus Stahl
- Teleskopierbares Zentralprofil mit 25 mm Alu-Klapprahmen
- Erhältlich in silber oder schwarz pulverbeschichtet
- **The inexpensive all-rounder!**
- *Telescopic Menuboard with snapframe*
- *Provides portrait and landscape adjustment easily*
- *Metal base plate with central upright pole*
- *Available in silver or black powder coated*



Art.-Nr.	Farbe	Plakatmaß (mm)	Max. Höhe (mm)
UMBT510NA4X2000	silber	210 x 297	1305
UMBT510NA3X2000	silber	297 x 420	1385
UMBT510BA4X2000	schwarz	210 x 297	1305
UMBT510BA3X2000	schwarz	297 x 420	1385



**Infoständer Economy, doppelseitig** | *Economy Menuboard, double sided*

- **Der preisgünstige Alleskönner!**
- In der Höhe und im Format einstellbar
- Stabile, runde Bodenplatte aus Stahl
- Teleskopierbares Zentralprofil mit doppelseitig nutzbarem Alu-Einschubrahmen
- Erhältlich in silber oder schwarz pulverbeschichtet
- **The inexpensive all-rounder!**
- *Telescopic Menuboard with slide-in frame*
- *Provides portrait and landscape adjustment easily*
- *Metal base plate with central upright pole*
- *Available in silver or black powder coated*



Art.-Nr.	Farbe	Plakatmaß (mm)	Max. Höhe (mm)
UMBD20NA4X2000	silber	210 x 297	1405
UMBD20NA3X2000	silber	297 x 420	1528
UMBD20BA4X2000	schwarz	210 x 297	1405
UMBD20BA3X2000	schwarz	297 x 420	1528

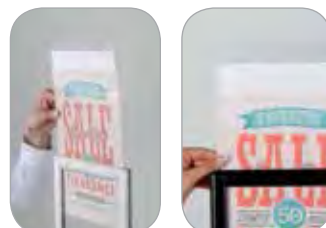
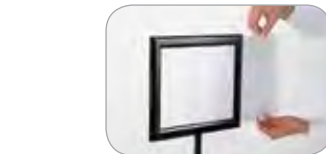

## Klassischer Infoständer | Classical Menuboard

- Der Klassiker unter den Infoständern
- 25 mm Klapprahmen im Hoch- oder Querformat nutzbar
- Gesamthöhe 1000 mm

- *The classic menuboard*
- *Snapframe can be used portrait or landscape position*
- *Total height 1000 mm*

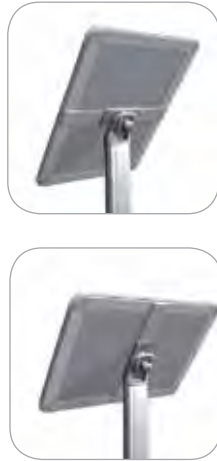

Art.-Nr. Gehrung	Art.-Nr. Rondo	Plakatmaß (mm)
UCMB1N05A4X1000	UCMB1N00A4X1000	210 x 297
UCMB1N05A3X1000	UCMB1N00A3X1000	297 x 420

## Flexibler Infoständer | Flexible Menuboard

- Infoständer mit 25 mm Profil-Klapprahmen
- Im Hoch- oder Querformat nutzbar
- Höhenverstellbares Gestell (Höhe max. 1205 mm, Höhe min. 865 mm)
- Klapprahmen in der Neigung einstellbar

- *Menuboard with 25 mm snapframe*
- *Snapframe can be used portrait or landscape position*
- *Height adjustable stand (High max. 1205 mm, High min. 865 mm)*
- *Snapframe can be adjusted in inclination*



Art.-Nr.	Plakatmaß (mm)	Höhe max. (mm)	Höhe min. (mm)
UDMB6005A4X1000	210 x 297	1205	865
UDMB6005A3X1000	297 x 420	1250	910

### Folder Infoständer | Folder Menuboard

- Infoständer mit Acrylablage und Ordner-Mechanik
  - Ideal zum Blättern von Speisekarten und Preislisten
  - DIN A4 Prospektbox optional
- *Menuboard with clear acrylic shelf and ring binder panel*
  - *Ideal for menu pages or pricelists*
  - *DIN A4 brochure holder optional*

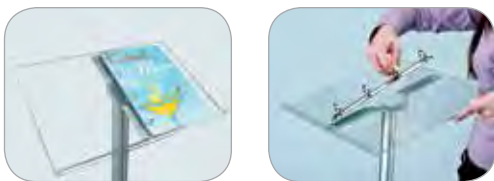

Art.-Nr.	Format (DIN)
UDMB2002A4X1000	2 x A4

### Infoständer AluDesign | AluDesign Menuboard

- Gestell und DIN A4 Prospektbox silberfarbig in Lochblech-Design
  - DIN A4 Klapprahmen im 26 mm Profil
  - Gesamthöhe 900 mm
- *Central board with DIN A4 leaflet-box silver coloured, made of perforated metal*
  - *26 mm snap frame in DIN A4 size*
  - *total height 900 mm*



Art.-Nr.	Format (DIN)
PRJ0100152	A4

## NEU! Kundenstopper SignPro Plus | A-Board SignPro Plus

- SignPro Plus ist ein sehr standfester, doppelseitiger Kundenstopper in neuem Design
  - Gestell aus strapazierfähigem Kunststoff
  - Plakatrahmen mit PET-Schutzfolie wird durch einen verdeckten Druckkopf geöffnet
  - Plakate werden mit Adhäsiv-Streifen fixiert
  - Mobil durch integrierte Laufrollen
- 
- *SignPro Plus is a very stable, double-sided A-Board for outdoor use*
  - *Complete new design*
  - *Made of durable plastic*
  - *Metal poster frame with the PET cover*
  - *Opened and closed by a hidden button*
  - *Posters are fixed with adhesive strips*
  - *Mobil thanks to integrated wheels*



Wir empfehlen im Außeneinsatz die Plakate auf Folie zu drucken.  
For outdoor use we recommend to print the posters on foil.



Art.-Nr.	Plakatmaß (mm)	Farbe
UPSP120024X1000	610 x 915	schwarz



## Eco WindSign PLUS und LITE | *Eco WindSign PLUS and LITE*

- Doppelseitiger Kundenstopper
  - Version PLUS mit 100 % wasserfestem Klapprahmen
  - Version LITE mit Plakatabdeckung durch PET-Schutzfolie
  - Ideal geeignet für windstarke Standflächen
  - Bewegliche Lagerung auf Stahlfedern
  - Speziell entwickelten Kunststoff-Fuß mit integrierten Laufrollen
  - Auf Anfrage auch als Version mit Aufnahme für Top-Schild produzierbar
- 
- *Double-sided pavement sign*
  - *Version PLUS with 100 % waterproof*
  - *Version LITE with PET cover as poster protection*
  - *Ideally suited for harsh weather conditions and open spaces*
  - *Two-wheeled plastic base to be filled with water or sand*
  - *Also available on request as version for header-application*



Art.-Nr.	Plakatmaß (mm)	Ausführung
UEWM000NA1X5002	594 x 841	LITE
UEWM000NAOX2000	841 x 1189	LITE
UEWM000LB1X2000	700 x 1000	LITE
UEWM000NA1X1000	594 x 841	PLUS
UEWM000NAOX1000	841 x 1189	PLUS
UEWM000NB2X1000	500 x 700	PLUS
UEWM000NB1X1000	700 x 1000	PLUS
UEWM000NB0X1000	1000 x 1400	PLUS
UEWM000NOOX5012	594 x 1682	PLUS



Wir empfehlen im Außeneinsatz die Plakate auf Folie zu drucken.  
For outdoor use we recommend to print the posters on foil.

## NEU! Kundenstopper WindSign FLEX | *A-Board WindSign FLEX*

- Moderner Kundenstopper in technischem Design
  - Standfest durch federnde Lagerung
  - Wasser befüllbarer Kunststoff-Fuß mit Laufrollen
  - Gestell aus strapazierfähigem Kunststoff
  - Einfacher Plakatwechsel durch flexiblen Kunststoff-Rahmen mit Antireflex-Folie
- 
- *Modern customer stopper in a technical design*
  - *Stable thanks to resilient mounting*
  - *Water-filled plastic foot with castors*
  - *Completely made of durable plastic*
  - *Easy poster change thanks to the flexible plastic frame with anti-reflective film*

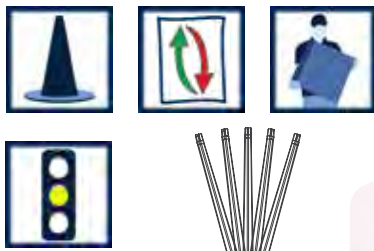

Art.-Nr.	Plakatmaß (mm)	Farbe
UPFS3300A1X2000	594 x 841	schwarz



Wir empfehlen im Außeneinsatz die Plakate auf Folie zu drucken.  
For outdoor use we recommend to print the posters on foil.

## WindPro® LED | WindPro® LED



- Innovativer, wasserdichter Kundenstopper in modernem Design
  - Umschaltbar mit Fernbedienung von „energiesparend - 650 bis 700 Lux“ in der Nacht, auf „sehr hell - 1000 - 1200 Lux“ am Tag
  - Betriebszeit (abhängig vom Modus) zwischen 12 und 24 Stunden
  - Leistungsstarke Lithium-Eisenphosphat Batterie unsichtbar im Kunststoff-Fuß verschlossen
  - Abschließbarer, schwarzer Passepartoutrahmen aus Polycarbonat
  - Das Plakat wird mit Klemmen fixiert
  - Transporthilfe ist im Lieferumfang enthalten
- *Innovative, waterproof pavement sign in modern design*
  - *The mode can be switched remote from "energy-saving - 650 - 700 Lux" in the night, to "bright - 1000 - 1200 Lux" during the day*
  - *The operation time is depending on mode 12-24 hours*
  - *The powerful LiFePO4 battery is hidden locked in the base – a digital display indicates the charge status of the battery*
  - *The decorative cover-frame with black passepartout is made of polycarbonate and is lockable*
  - *The poster is fixed with clamps*
  - *Carry tool is included in delivery*

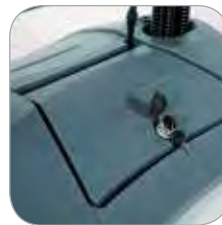

**UYUP480945X1000**  
 Transporthilfe (Zugkraft max. 6-8 kg)  
 Carry tool (Pulling force 6-8 kg max.)



Art-Nr.	Plakatmaß (mm)
USWL000NA1X9999	594 x 841
USWL000NA1X5000	8 x 210 x 297
Zubehör	
UYPSWL0010X1000	Batterie
TZZZ998701X2000	Kabel-Schloss, 2100 mm mit Schlaufe und Zahlencode
UYPSWL0040X1000	Ladekabel/ Netzteil

## NEU! WindPro® LED Economy | *WindPro® LED Economy*

- Wasserfester LED Kundenstopper für den Outdoor Einsatz
  - Helligkeit kann in 2 Stufen reguliert werden
  - Betriebszeit abhängig von der eingestellten Helligkeit zwischen 8 und 16 Stunden
  - Leistungsstarke Lithium-Eisenphosphat Batterie unsichtbar im Kunststoff-Fuß verschlossen
  - Einfacher Plakatwechsel durch bewährte Klapprahmen Technik
  - Wasserfest durch übergroße PET- Schutzfolie und integrierte Dichtung
- *Waterproof LED pavement sign for outdoor use*
  - *Brightness can be adjusted in 2 levels*
  - *Operating time depending on the set brightness between 8 and 16 hours*
  - *Powerful LiFePO4 battery invisibly locked in the plastic base*
  - *Easy change of poster by proven snapframe technology*
  - *Waterproof by oversized cover sheet and integral sealing*



Art.-Nr.:	Farbe	Plakatmaß (mm)
USWL000BA1X2000	schwarz	594 x 841
USWL000NA1X2000	silber	594 x 841
Art.-Nr.:	Bezeichnung	
UYUP480945X1000	Transporthilfe	
UYPSWL0010X1000	Ersatz Akku	



**UYUP480945X1000**  
Transporthilfe separat erhältlich  
*Carry tool available seperately*



**UYPSWL0010X1000**  
Ersatz Akku  
*Spare battery*



## WindPro® LITE | *WindPro® LITE*

- Die Economy Version!
  - Patentierte Doppelfeder-Ausführung
  - Formschönes 33 mm Design-Klemmprofil
  - Safe Corner Ecken
  - Plakatabdeckung durch PET-Schutzfolien
  - Wasserablauföffnungen im Unterprofil
- *The economy version!*
  - *Patented double-spring version*
  - *Elegant 33 mm design-profile with safe corner solution*
  - *Poster cover by PET-sheet*
  - *Water drainage holes avoid moisture*

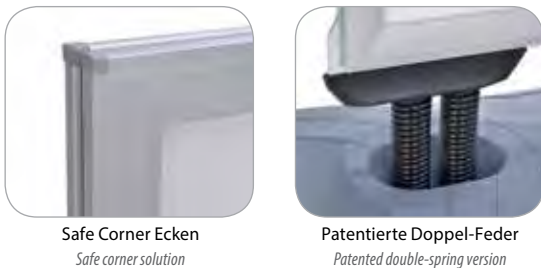

Art.-Nr.	Plakatmaß (mm)	Farbe
1154037	594 x 841	schwarz
1154029	841 x 1189	schwarz
1154048	500 x 700	schwarz
1154030	700 x 1000	schwarz
1154038	594 x 841	silber
1154031	841 x 1189	silber
1154047	500 x 700	silber
1154032	700 x 1000	silber



Wir empfehlen im Außeneinsatz die Plakate auf Folie zu drucken.  
*For outdoor use we recommend to print the posters on foil.*

## WindPro® PLUS | WindPro® PLUS



- Die Premium Version!
  - Patentierte Doppelfeder-Ausführung
  - Robustes 44 mm Klemmprofil
  - Safe Corner Ecken
  - Wasserdicht durch übergroße Schutzfolie und im Unterprofil integrierte Dichtung
  - Einfacher Plakatwechsel dank Scharnierfunktion und Adhäsiv-Streifen
  - Design Kunststoff-Fuß
- *The premium version*
  - *Patented double-spring version*
  - *Sturdy 44 mm design-profile with safe corner solution*
  - *Waterproof by oversized anti-glare PET cover sheet and integrated sealing*
  - *Easy poster change thanks to hinge function and adhesive stripes to prefix poster*
  - *Design Waterbase*



Art.-Nr.	Plakatmaß (mm)	Farbe
1154017	594 x 841	schwarz
1154046	841 x 1189	schwarz
1154044	700 x 1000	schwarz
1154018	594 x 841	silber
1154045	841 x 1189	silber
1154043	700 x 1000	silber



## WindPro® | WindPro® & WindPro® Schwarz | WindPro® Black



- Der Bestseller!
  - Patentierte Doppelfeder-Ausführung
  - Bewährtes 40 mm Klemmprofil
  - Safe Corner Ecken
  - Wasserfest durch übergroße Schutzfolie und im Unterprofil eingeklebte Gummidichtung
  - Design Kunststoff-Fuß
- *The bestseller!*
  - *Patented double-spring version*
  - *Proven 40 mm profile with safe corner solution*
  - *Waterproof by oversized anti-glare PET cover sheet and sealing*
  - *Design waterbase*



Art.-Nr.	Plakatmaß (mm)	Ausführung	Farbe
1154033	594 x 841	Standard	schwarz
1154050	594 x 841	mit Topschild-Aufnahme	schwarz
1154034	841 x 1189	Standard	schwarz
1154007	500 x 700	Standard	schwarz
1154008	700 x 1000	Standard	schwarz
1154035	594 x 841	Standard	silber
1154051	594 x 841	mit Topschild-Aufnahme	silber
1154036	841 x 1189	Standard	silber
1154011	500 x 700	Standard	silber
1154012	700 x 1000	Standard	silber



Topschild-Aufnahme  
Header-application



Mit permanentem Branding  
With permanent branding



## NEU! WindPro® WOOD | WindPro® WOOD



- Beidseitige Kreidetafel auf standfestem Kunststoff-Fuß mit Laufrollen
  - Massives, dunkel lasiertes Kiefernholz
  - Doppelfedern sorgen für einen sicheren Stand bei Wind und Wetter
  - Beschreibbar und feucht oder nass abwischbar und magnethaftend für Poster-Taschen
  - Mit Magnetfolien auch für Plakate nutzbar
- *Double-sided chalkboard on sturdy plastic foot with castors*
  - *Solid, dark glazed firewood*
  - *Double springs ensure a secure position in wind and weather*
  - *Writable and moist or wet wipeable and ideal for magnetic poster pockets*
  - *With magnetic foil also usable as poster stand*



Art.-Nr.	Kreidetafel (mm)	Ausführung	
1154057	460 x 680	Magnethaftend	
1154052	590 x 780	Magnethaftend	
Art.-Nr.	Beschreibung	Breite (mm)	Farbe
UYAKLM1251X1000	Kreidestifte 5er Set	10	bunt
UYAKLM1250X1000	Kreidestifte 3er Set	10	weiß
UYUP397000X1000	Magnete, 10er Set	20	
Art.-Nr.	Beschreibung	Plakatmaß (mm)	Farbe
UPCMOB00A4X2000	Magnetfolie, DIN A4	210 x 297	schwarz
UYPSWPW010X2000	Magnetfolie, 460 x 680 mm		schwarz
UYPSWPW020X1000	Magnetfolie, 590 x 780 mm		schwarz



## NEU! Kundenstopper MaxiFrame WOOD | A-Board MaxiFrame WOOD

- Multifunktionaler Holz-Kundenstopper
  - Ideal geeignet für Textildrucke oder als Kreidetafel (Beschreibbar und feucht oder nass abwischbar)
  - Zertifiziertes Buche-Vollholz, dunkel lasiert
  - Geeignet für den Inneneinsatz
- *Multifunctional wooden A-Board*
  - *Ideally suited for textile prints or as a chalkboard (Writable and moist or wet wipeable)*
  - *Certified solid beech wood, dark lacquered*
  - *For indoor use*



Art.-Nr.	Plakatformat (mm)
PRJ0101203	594 x 841



## NEU! Holz-Kundenstopper MULTI Plus | *Wooden A-Board MULTI Plus*

- Der Alleskönner mit integriertem Top-Schild
  - Outdoor Plakatständer aus massivem Buchenholz, dunkel lasiert, produziert aus zertifiziertem Holz
  - Optimaler Plakatschutz durch Magnetfolie
  - Stabile Metall-Scharniere und Traverse
  - Ohne Magnetfolie auch nutzbar als Kreidetafel (Beschreibbar und feucht oder nass abwischbar)
  - Einfacher Top-Schild Wechsel durch seitlichen Einschub mit Abdichtung
- *The all-rounder with an integrated top shield*
  - *Outdoor poster stand made of solid certified beech wood, dark lacquered*
  - *Waterproof thanks to magnetic cover sheet*
  - *Stable metal hinges and lock*
  - *Can also be used as a chalkboard without magnetic cover sheet (can be written on and wiped with a damp or wet cloth)*
  - *Easy change of header thanks to a lateral insertion – closed by a seal*



Art.-Nr.	Farbe	Plakatmaß (mm)	Topschild (mm)
UWOPD000A1X5000	Buche dunkel lasiert	594 x 841	594 x 200



## NEU! Holz Kundenstopper MULTI | *Wooden A-Board MULTI*

- Der Allrounder!
  - Outdoor Plakatständer aus massivem Buchenholz, dunkel lasiert, produziert aus zertifiziertem Holz
  - Optimaler Plakatschutz durch Magnetfolie
  - Stabile Metall-Scharniere und Traverse
  - Ohne Magnetfolie auch nutzbar als Kreidetafel (Beschreibbar und feucht oder nass abwischbar)
- *The all-rounder!*
  - *Outdoor poster stand made of solid beech wood, dark glazed, made of certified wood*
  - *Poster protection by magnetic foil*
  - *Sturdy metal hinges and locker*
  - *Without magnetic foil also usable as chalkboard (Writable and moist or wet wipeable)*



Art.-Nr.	Plakatmaß (mm)
UWODD00000X5001	594 x 841 mm
Art.-Nr.	Beschreibung
UYUP085000X5040	Magnetfolie



## Kundenstopper Outdoor | A-Board for Outdoor

- Einfache Lösung für den Außenbereich
- Stabiles Standgestell
- 32 mm Klapprahmen mit Stahl-Rückwand
- Hochwertige PET Schutzfolien
- Wasserablauföffnungen im Unterprofil

- *Basic solution for outdoor*
- *Stable legs*
- *32 mm snapframe with metall-backing*
- *PET cover sheets*
- *Water drainage holes*



Topschild für Kundenstopper



Prospektkorb für Kundenstopper-Transverse

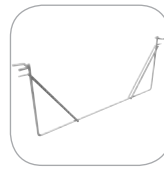

Aufsatzhalterung für Kundenstopper

Art.-Nr. Gehrung	Art.-Nr. Rondo	Plakatmaß (mm)	Farbe
UAB325HNA2X1000	UAB320HNA2X1000	420 x 594	silber
UAB325HNA1X1000	UAB320HNA1X1000	594 x 841	silber
UAB325HNAOX1000	UAB320HNAOX1000	841 x 1189	silber
UAB325HNB2X1000	UAB320HNB2X1000	500 x 700	silber
UAB325HNB1X1000	UAB320HNB1X1000	700 x 1000	silber
UAB325HBA2X2000	UAB320HBA2X2000	420 x 594	schwarz
UAB325HBA1X7700	UAB320HBA1X2000	594 x 841	schwarz
UAB325HBAOX2000	UAB320HBAOX2000	841 x 1189	schwarz
UAB325HBB2X2000	UAB320HBB2X2000	500 x 700	schwarz
UAB325HBB1X2000	UAB320HBB1X2000	700 x 1000	schwarz
Art.-Nr.	Bezeichnung	Format	Format
UYTT0000A1X1000	Aufsatzhalterung	DIN A1	DIN A1
UYTS3000A4X1000	Prospektkorb	DIN A4	DIN A4
UYFT0000A1X1000	Top-Schild	DIN A1	DIN A1



Wir empfehlen im Außeneinsatz die Plakate auf Folie zu drucken.  
For outdoor use we recommend to print the posters on foil.

## Kundenstopper Outdoor Wasserfest | A-Board for Outdoor Waterproof

- Wasserfeste Lösung für den Außenbereich
- Stabiles Aluminium Standgestell
- 32 mm Klapprahmen mit Stahl-Rückwand
- Ecken auf Gehrung
- Wasserdicht durch PET-Folientasche mit umlaufender Dichtung
- Wasserablauföffnungen im Unterprofil

- *Waterproof solution for outdoor*
- *Stable legs made of Aluminium*
- *32 mm snapframe with metall-backing*
- *Mitred corners*
- *Waterproof thanks to PET poster-pocket with rubber sealing*
- *Water drainage holes*

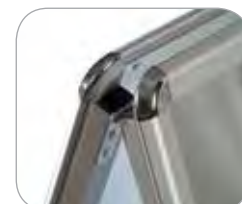

Wasserfeste Version mit Rondo Ecken auf Anfrage  
Waterproof version with rounded corners on request!



Genial einfacher Plakatwechsel durch klappbare Postertasche  
Easy poster change thanks poster pocket

Art.-Nr.	Beschreibung	Farbe
UAB325HNA2X5001	Kundenstopper Classic, Gehrung, Metallrückwand, Folientasche, A2	silber
UAB325HNA1X5000	Kundenstopper Classic, Gehrung, Metallrückwand, Folientasche, A1	silber
UAB325HBA1X5000	Kundenstopper, schwarz, Gehrung, Metallrückwand, Folientasche, A1	schwarz
UAB325HNAOX5000	Kundenstopper Classic, Gehrung, Metallrückwand, Folientasche, A0	silber
UAB325HNB2X5000	Kundenstopper Classic, Gehrung, Metallrückwand, Folientasche, B2	silber
UAB325HNB1X5001	Kundenstopper Classic, Gehrung, Metallrückwand, Folientasche, B1	silber

## Kundenstopper Indoor | A-Board for Indoor

- Günstige Lösung für den Innenbereich
- Stabiles Standgestell
- 25 mm Klapprahmen mit PS-Rückwand

- *Inexpensive solution for indoor*
- *Stable legs*
- *25 mm snapframe with PS-backing*



Aufsatzhalterung für Kundenstopper



DIN A4 Prospektkorb für Kundenstopper-Traverse

Art.-Nr.	Ausführung	Plakatmaß (mm)
UAB255HNA2X1000	Gehrung	420 x 594
UAB255HNA1X1000	Gehrung	594 x 841
UAB255HNB2X1000	Gehrung	500 x 700
UAB255HNB1X1000	Gehrung	700 x 1000
UAB250HNA2X1000	Rondo	420 x 594
UAB250HNA1X1000	Rondo	594 x 841
UAB250HNB2X1000	Rondo	500 x 700
UAB250HNB1X1000	Rondo	700 x 1000
Art.-Nr.	Bezeichnung	Format
UYTT0000A1X1000	Aufsatzhalterung	DIN A1
UYTS3000A4X1000	Prospektkorb	DIN A4
UYFT0000A1X1000	Top-Schild	DIN A1



Topschild optional

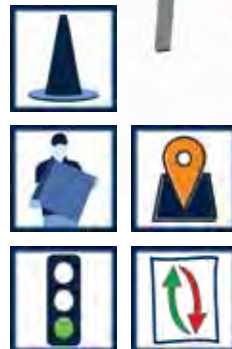

Topschild für Kundenstopper



## NEU! Kundenstopper Wheel | A-Board Wheel

- Auffälliger Outdoor-Kundenstopper
- Sehr standfest
- Metallrahmen wird auch zum Rollen benutzt
- Logofläche oberhalb des Rahmens
- Als Wetterfeste (Spritzwassergeschützt) und wasserfeste Version erhältlich
- Farbe schwarz, andere RAL Farben auf Anfrage!

- *Showy outdoor customer stopper*
- *Very stable*
- *Metal wheel is also used for rolling*
- *Header panel can be used for permanent branding*
- *Available as weatherproof (splash water protected) and waterproof version*
- *Colour black, other RAL colors on request!*



Art.-Nr.	Beschreibung	Plakatmaß
PRJ0101125	Wetterfest	594 x 841
PRJ0101386	Wasserfest	594 x 841



Laufrollen optional / Wheels optional



Kundenstopper PremiumPlus | A-Board PremiumPlus

- Design Kundenstopper mit hochwertiger Aluminiumkonstruktion
  - Gestell aus stabilem Rechteckprofil mit zwei aufmontierten 30 mm Klapprahmen
  - PS-Rückwände
  - PET-Schutzfolien
  - Einfacher Wechsel der Logoplatte durch Klemmleisten-Technik
  - Wasserfeste Version auf Anfrage\*
- Design pavement sign with high-quality aluminium construction
  - Stand made of sturdy rectangular profile with two mounted 30 mm snap frames
  - Polystyrene backings
  - PET cover-sheets
  - Easy change of header by snap-technology
  - Waterproof version on request\*



Art.-Nr.	Plakatmaß (DIN/mm)
UAPO305NA2X1000	A2
UAPO305NA1X1000	A1
UAPO305NA0X1000	A0
UAPO305NB2X1000	500 x 700
UAPO305NB1X1000	700 x 1000

\* Wir empfehlen im Außeneinsatz die Plakate auf Folie zu drucken.  
 \* For outdoor use we recommend to print the posters on foil.

## SwingPro® / SwingPro® LITE | *SwingPro® / SwingPro® LITE*



- Outdoor Kundenstopper mit doppelseitigem Klapprahmen
- Ideal geeignet für stark windexponierte Standflächen
- Bewegliche Lagerung auf den patentierten Doppelfedern sowie den speziell entwickelten T-Standfüßen
- Auf Anfrage auch als Sonder-Version mit Aufnahme für Top-Schild produzierbar

- *Outdoor pavement sign with double sided snapframe*
- *Ideally suited for harsh weather conditions and open spaces*
- *Sturdy stand with t-feet*
- *Also available on request as special version for header-application*



\*Wir empfehlen bei der LITE Version im Außeneinsatz die Plakate auf Folie zu drucken.  
\*For outdoor use we recommend to print the posters on foil for the LITE version.



Art-Nr.	Farbe	Modell	Ausführung	Plakatmaß (mm)
1154025	schwarz	SwingPro	wasserfest	594 x 841
1154026	schwarz	SwingPro	wasserfest	841 x 1189
1154027	schwarz	SwingPro	wasserfest	500 x 700
1154028	schwarz	SwingPro	wasserfest	700 x 1000
1154020	schwarz	SwingPro LITE	wetterfest	594 x 841
1154019	schwarz	SwingPro LITE	wetterfest	841 x 1189
1154021	schwarz	SwingPro LITE	wetterfest	700 x 1000
1154001	silber	SwingPro	wasserfest	594 x 841
1154002	silber	SwingPro	wasserfest	841 x 1189
1154003	silber	SwingPro	wasserfest	500 x 700
1154004	silber	SwingPro	wasserfest	700 x 1000
1154023	silber	SwingPro LITE	wetterfest	594 x 841
1154022	silber	SwingPro LITE	wetterfest	841 x 1189
1154024	silber	SwingPro LITE	wetterfest	700 x 1000

**Stahlrohr Kundenstopper, abgerundet** | Iron A-Board

- Stabiler Kundenstopper aus 25 mm Stahlrohr
- Integriertes Top-Schild
- Optimaler Plakatschutz durch Magnetfolie
- Erhältlich in silber, weiß oder schwarz pulverbeschichtet

- *Stable customer stopper made of 25 mm tubular steel*
- *Integrated top sign*
- *Poster protection by magnetic foil*
- *Available in silver, white or black powder coated*



Art.-Nr.	Plakatmaß (mm)	Farbe
UABD255NA1X1000	594 x 841	weiß
UABD255BA1X1000	594 x 841	schwarz

**Kundenstopper Vario** | A-Board Vario

- Mobiler Outdoor-Kundenstopper
- Wasserfester 25 mm Klapprahmen
- Feststellbare Laufrollen
- Logofläche unterhalb des Rahmens

- *Mobile outdoor customer stopper*
- *25 mm waterproof snap frame*
- *Lockable castors*
- *Bottom panel can be used for permanent branding*



Art.-Nr.	Plakatmaß (mm)	Farbe
PRJ0100829	594 x 841	silber eloxiert

## Hunde Tankstelle | Dog Station



- Stabiler Bodenkörper aus Aluminium, RAL 7016 pulverbeschichtet
- 2 Näpfe aus Edelstahl mit 2,5 Liter Füllmenge
- Wasserfester DIN A1 Klapprahmen
- Abmessung 650 x 1000 x 400 mm

- Stable aluminum base, powder-coated in RAL 7016
- 2 stainless steel bowls, 2.5 liter capacity
- Waterproof DIN A1 snap frame
- Dimensions 650 x 1000 x 400 mm



Art.-Nr.	Plakatformat
7000048	DIN A1

## Holz Kundenstopper Slide | Wooden A-Board Slide

- Gehwegtafel aus massivem Buchenholz, dunkel lasiert
- Einfacher Austausch der Tafel durch offene Oberseite
- Tafel kann gedreht und doppelseitig für unterschiedliche Informationen genutzt werden
- Beschreibbar und feucht oder nass abwischbar und magnethaftend für Infotaschen
- Produziert aus zertifiziertem Buchenholz

- Walkway made of solid beech wood, dark glazed
- Easy use of other panels thanks to open top
- Panel can be turned around used double-sided for different information
- Writable, writable and moist or wet wipeable and magnetic for the use of PET pockets
- Made of certified beech wood



Art.-Nr.	Kreidetafel (mm)	Ausführung	Farbe
UWTC006078X2000	600 x 780	Outdoor	Buche, dunkel
Art.-Nr.	Beschreibung	Breite (mm)	Farbe
UYAKLM1251X1000	Kreidestifte 5er Set	10	bunt
UYAKLM1250X1000	Kreidestifte 3er Set	10	weiß
UYUP397000X1000	Magnete DM = 20 mm, 10er Set		
UPCM0B00A4X2000	PET Pocket		schwarz



**NEU!** Holz-Kundenstopper Economy Outdoor | *Wooden A-Board Economy Outdoor*

- Gehwegtafel aus massivem Buchenholz, dunkel lasiert, produziert aus zertifiziertem Holz
- Schwarze mit Tafellack bedruckte Stahl-Rückwand
- Beschreibbar, feucht oder nass abwischbar und magnetaftend
- Metall-Scharniere und Traverse

- *Walkway made of solid certified beech wood, dark lacquered*
- *Black steel chalkboard*
- *Writable, moist or wet wipeable and magnetic*
- *Metal hinges and traverse*

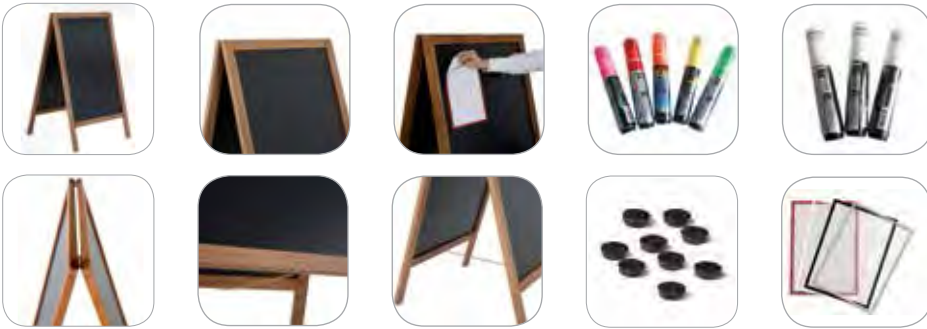

Art.-Nr.	Kreidetafel (mm)		
UWODD04668X2000	460 x 680		
UWODD06012X2000	600 x 1200		
Art.-Nr.	Beschreibung	Breite (mm)	Farbe
UYAKLM1251X1000	Kreidestifte 5er Set	10	bunt
UYAKLM1250X1000	Kreidestifte 3er Set	10	weiß
UYUP397000X1000	Magnete DM = 20 mm, 10er Set		
UPCM0B00A4X2000	PET Pocket		schwarz



**NEU!** Holz Kundenstopper, Economy Indoor | *Wooden A-Board, Economy Indoor*

- Gehwegtafel aus massivem Buchenholz, natur
- Schwarze MDF-Kreidetafel
- Beschreibbar und feucht abwischbar mit einem Microfaser Tuch

- *Walkway made of solid beech wood, nature*
- *Black MDF-chalkboard*
- *Writable and wet wipeable with a microfibre cloth*



Art.-Nr.	Außenmaß (mm)	Beschreibung	Farbe
UWID006078X2000	600 x 780	Holz-Kundenstopper, Indoor	Buche
Art.-Nr.	Ausführung	Breite (mm)	Farbe
UYAKLM1251X1000	Kreidestifte 5er Set	10	bunt
UYAKLM1250X1000	Kreidestifte 3er Set	10	weiß

## NEU! Holz Kundenstopper Easel | Wooden A-Board Easel

- Gehwegaufsteller aus massivem Buchenholz, dunkel lasiert
- Magnetische Kreidetafel, beschreibbar und feucht oder nass abwischbar
- Walkway made of solid beech wood, dark lacquered
- Magnetic chalkboard for the use of PET pockets, writable and moist or wet wipeable

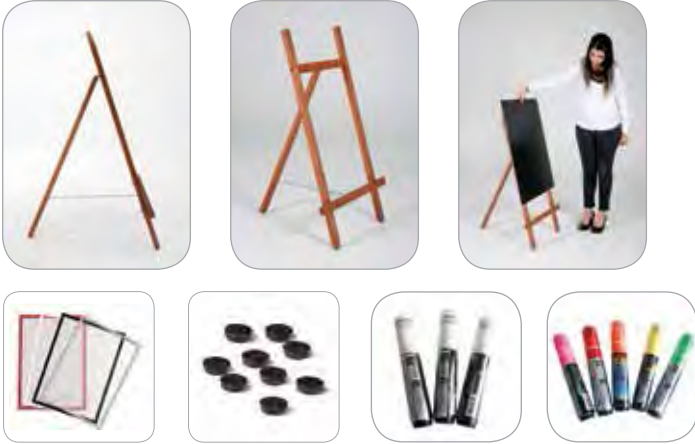

Art.-Nr.	Beschreibung	Ausführung	Abmessung (mm)
UWBAD1000X2000	Staffelei	Buche, dunkel lasiert	520 x 1030
UYPBAD1020X1000	Kreidetafel	magnetisch	600 x 800
Art.-Nr.	Beschreibung	Breite (mm)	Farbe
UYAKLM1251X1000	Kreidestifte 5er Set	10	bunt
UYAKLM1250X1000	Kreidestifte 3er Set	10	weiß
UYUP397000X1000	Magnete DM = 20 mm, 10er Set		
UPCM0B00A4X2000	PET Pocket		schwarz



## NEU! Holz-Kundenstopper WoodMak | Wooden A-Board WoodMak

- Gehwegtafel aus massivem Buchenholz, dunkel lasiert, produziert aus zertifiziertem Holz
- Einfacher Austausch der Tafel durch offene Oberseite
- Logodruck auf Top optional
- Beschreibbar, feucht oder nass abwischbar und magnethaftend für Infotaschen
- Walkway made of solid certified beech wood, dark lacquered
- Easy change of chalkboard thanks to open top
- Branding on top optional
- Writable, moist or wet wipeable and magnetic for the use of PET pockets



Art.-Nr.	Kreidetafel (mm)	Ausführung	Farbe
UWMC06078X2000	600 x 780	Kundenstopper	Buche, dunkel
UYPWMC0010X2000	600 x 780	Kreidetafel	schwarz
Art.-Nr.	Beschreibung	Breite (mm)	Farbe
UYAKLM1251X1000	Kreidestifte 5er Set	10	bunt
UYAKLM1250X1000	Kreidestifte 3er Set	10	weiß
UYUP397000X1000	Magnete DM = 20 mm, 10er Set		
UPCM0B00A4X2000	PET Pocket		schwarz



## Werbe-Fahrradständer Economy | Advertising -Bicyclestand Economy

- Vielseitig einsetzbares Outdoor Display
  - Plakatständer mit wasserfestem Klapprahmen
  - Einstellplätze für 4 Fahrräder
  - Mobil durch integrierte Laufrollen
- Versatile outdoor display for poster advertising
  - Poster stand with waterproof snap frame
  - Parking spaces for 4 bikes
  - Mobile thanks to integrated castors



Art.-Nr.	Plakatmaß (mm)
UIB205CNA1X5003	594 x 841

## NEU! Werbe-Fahrradständer Premium | Advertising -Bicyclestand Premium

- Kombination aus Fahrradständer und Plakatwerbung
  - Für zweiseitige Radeinstellung geeignet
  - Standfest durch T-Kippschutz Füße
  - Stabiler, feuerverzinkter Stahlrahmen mit bogenförmigen Bügeln
  - Mobil dank integrierter Laufrollen
  - Gesamthöhe 1750 mm
- Combination of bike stand with double sided, poster advertising
  - Double sided waterproof snapframe
  - Ideal for twin-sided bicycle parking
  - Stable thanks to anti-tip feet
  - Sturdy hot-dip galvanized steel frame with bow-shaped hoops
  - Mobile thanks to integrated rollers
  - Total height 1750 mm

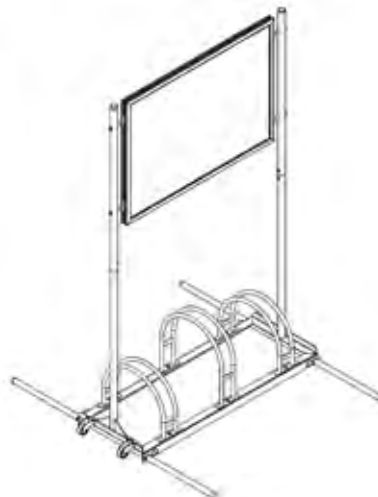

Art.-Nr.	Ausführung	Plakatmaß (mm)
PRJ0101441	doppelseitig	841 x 594

## NEU! Bügelparker MULTI 2, 3, 4, 5, 6 | Hoop Parker MULTI 2, 3, 4, 5, 6

- Der Bestseller bei den Einstellparkern!
- Stabiler, feuerverzinkter Fahrradständer mit Bügeln aus 17 mm Rundrohr
- Einseitige Radeinstellung
- Vorbereitet zur Reihenverbindung
- Bügel werden vor Ort einfach am Rahmen verschraubt
- Durch 55 mm Bügelabstand auch für Mountainbikes geeignet
- Demontierte Lieferung ermöglicht preiswerten Paketdienst-Versand
- Erhältlich in 5 Größen (2-6 Einstellplätze)
- **Ausführung in Edelstahl auf Anfrage!**

- *The bestseller!*
- *Stable, hot-dip galvanized bicycle stand with hoops made of 17 mm round tube*
- *Single-sided parking*
- *Ready made for row connection*
- *Bolted tubular hoops are mounted at site*
- *Suitable for mountain bikes thanks to the 55 mm hoop spacing*
- *Disassembled delivery enables inexpensive parcel delivery*
- *Available in 5 sizes (for 2-6 bikes)*
- **Stainless steel version on request**



Art.-Nr.	Einstellplätze	Rahmenmaß (mm)
PRJ0101447	2	700 x 390
PRJ0101055	3	1050 x 390
1258000	4	1400 x 390
1258001	5	1750 x 390
1258002	6	2100 x 390



## NEU! Bügelparker MULTI 2+ und MULTI 1+ | Hoop Parker MULTI 2+ and MULTI 1+

- Der clevere Einstellparker!
- Stabiler, feuerverzinkter Fahrradständer mit Bügeln aus 17 mm Rundrohr
- Einseitige Radeinstellung
- Modular erweiterbar durch Version MULTI 1+
- Schwarze Kunststoff-Endkappen
- Demontierte Lieferung ermöglicht preiswerte Paketdienst-Versand
- Bügel werden vor Ort einfach am Rahmen verschraubt

- *The smart solution!*
- *Stable, hot-dip galvanized bicycle stand with hoops made of 17 mm round tube*
- *Single-sided parking*
- *Modular extendable by version MULTI 1+*
- *Black plastic endcaps*
- *Disassembled delivery enables inexpensive parcel delivery*
- *Bolted tubular hoops are mounted at site*

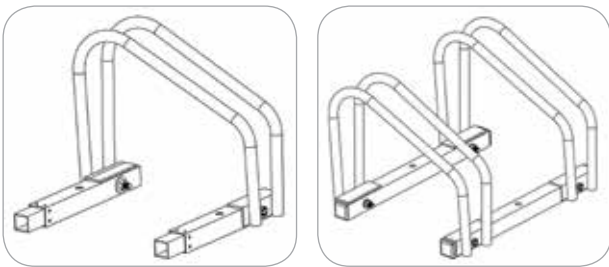

Art.-Nr.	Einstellplätze	Ausführung	Breite (mm)
PRJ0101053	2	Basisversion 2+	390
PRJ0101054	1	Erweiterungsmodul 1+	235





## NEU! Bogenparker MULTI 3 | Bow-Frame Parker MULTI 3

- Eleganter Einstellparker!
  - Stabiler, feuerverzinkter Fahrradständer mit bogenförmigen Bügeln aus 17 mm Rundrohr
  - Ein- oder doppelseitige Radeinstellung
  - Vorbereitet zur Reihenverbindung
  - Demontierte Lieferung ermöglicht preiswerten Paketdienst-Versand
  - Bogen werden vor Ort einfach am Rahmen verschraubt
  - Durch 55 mm Bogenabstand auch für Mountainbikes geeignet
- *The bestseller!*
  - *Stable, hot-dip galvanized bicycle stand with bows made of 17 mm round tube*
  - *Single or double-sided parking*
  - *Ready made for row connection*
  - *Disassembled delivery enables inexpensive parcel delivery*
  - *Bolted bow-shaped tubular hoops are mounted at site*
  - *Suitable for mountain bikes thanks to the 55 mm hoop spacing*

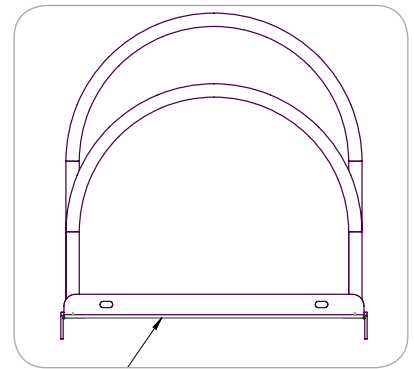
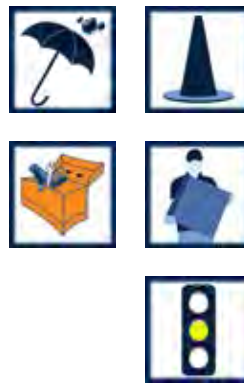
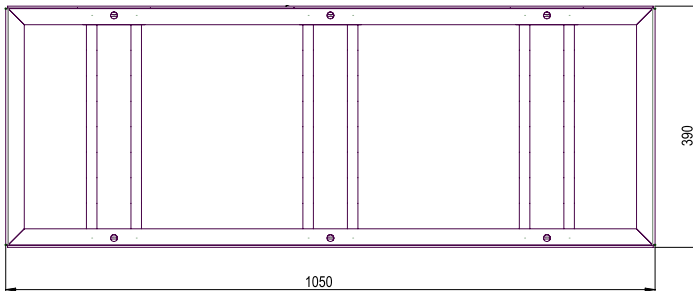

Art.-Nr.	Einstellplätze	Rahmenmaß (mm)
PRJ0101056	3	1050 x 390

## NEU! Wandparker SOLO | Wall mounted Parker SOLO

- Einzel- Einstellparker für Wandmontage
  - Stabiler, feuerverzinkter Fahrradständer aus 17 mm Rundrohr
  - Reihenmontage im Abstand von 650 mm möglich
  - Durch 55 mm Bogenabstand auch für Mountainbikes geeignet
- *Single parking space for wall mounting*
  - *Stable, hot-dip galvanized bicycle stand made of 17 mm round tube*
  - *Row mounting possible with a distance of 650 mm*
  - *Also suitable for mountain bikes thanks to the 55 mm arc spacing*

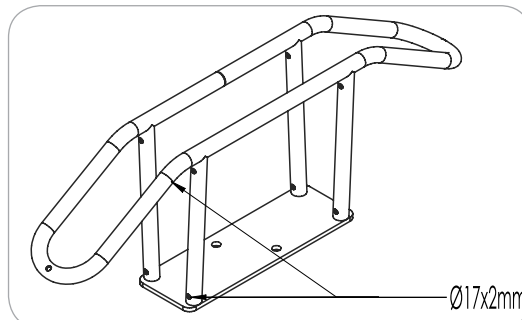
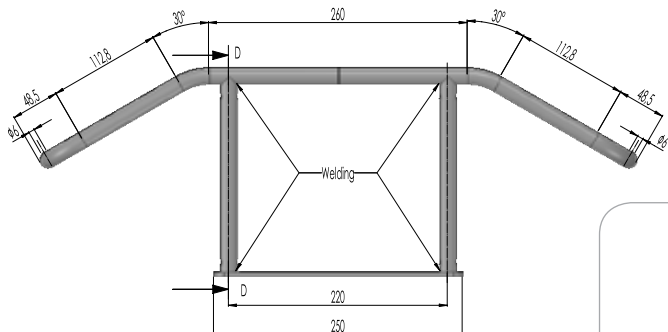

Art.-Nr.	Ausführung
PRJ0101433	Wandmontage

### NEU! Hängeparker WALL | *Hanging Parker WALL*



- Raumsparender Fahrradhalter
  - Einfache Wandmontage der Grundplatte mit Dübeln
  - Robuste 17 mm Rundrohr-Konstruktion
  - Kunststoff-Felgenschutz
  - Mindestraumhöhe 2000 mm
  - Stellraumtiefe etwa 1200 mm
  - Einstellwinkel 90 Grad
- *Space-saving bike holder*
  - *Simple wall mounting of the base plate with dowels*
  - *Sturdy 17 mm round tube construction*
  - *Plastic rim protection*
  - *Recommended room height min 2000 mm*
  - *Depth of storage room approx. 1200 mm*
  - *Setting angle 90 degrees*

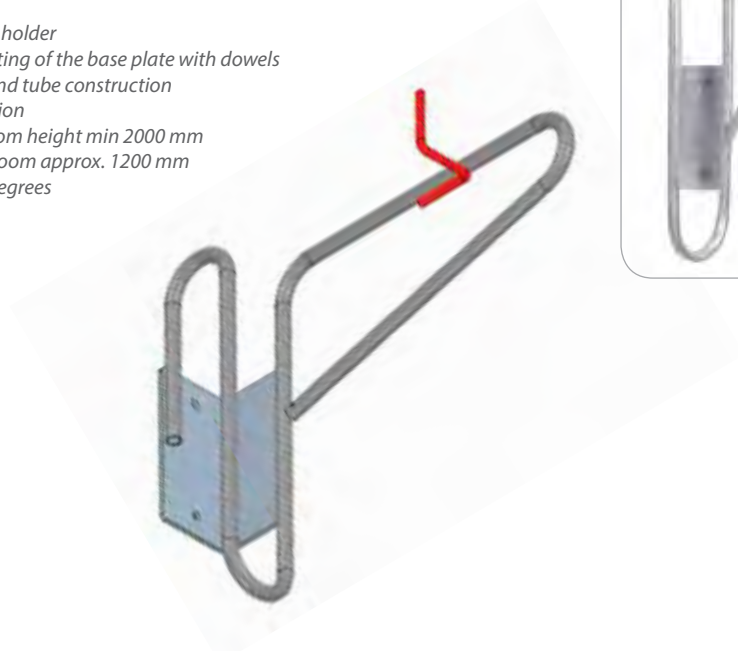

Art.-Nr.	Ausführung
PRJ0101434	Wandmontage

### NEU! Plakatständer Economy | *Poster Stand Economy*

- Kostengünstiger einseitiger Plakatständer
- Stabile Stahl-Fußplatte in RAL 9006
- Teilbares, ovales Zentralprofil mit integrierter Systemnut
- Klapprahmen im 25 mm Profil auf Gehrung
- Mit Zusatzrahmen auch doppelseitig nutzbar
- Paketdienstfähige Verpackung

- *Inexpensive single-sided poster stand*
- *Stable steel base plate in RAL 9006*
- *Dividable elliptic central upright with inbuilt system groove*
- *Mitred snap frame in 25 mm profile*
- *Additional frame for double sided use as option*
- *Packaging suitable for parcel service*

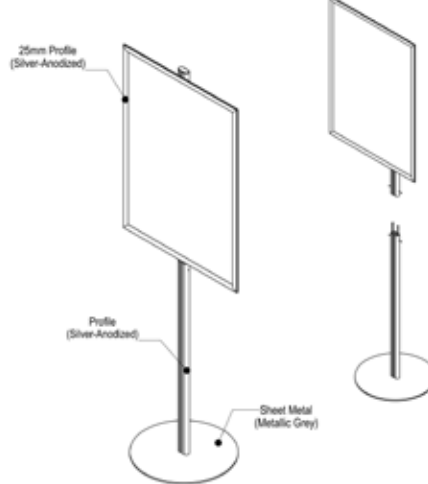

Art.-Nr.	Ausführung	Plakatmaß (mm)
PRJ0101428	einseitig	594 x 841
UFSL0000A1X2000	Zusatzrahmen	594 x 841

## Plakatständer PURE | Info Board PURE

- Doppelseitiger Poster-Ständer
- Silberfarbiges Gestell in Kombination mit zwei Klapprahmen im 25mm Profil
- Einfacher und schneller Motivwechsel durch bewährte Klapprahmenteknik
- Stabiler Stand durch Stahl-Fußplatte und Stahl-Gestell

- *Double-sided poster stand*
- *Silver colored frame in combination with two snap-frames in 25mm profile*
- *Easy and fast poster change through proven snap-frame technology*
- *Stable stand thanks to steel base plate and sturdy steel frame*



Art.-Nr.	Anwendung	Farbe	Format	Abmessung (mm)
PRJ0101232	Doppelseitig	silber	2 x DIN A1	630 x 1305 x 330
PRJ0101233	Doppelseitig	schwarz	2 x DIN A1	630 x 1305 x 330



Version schwarz.  
Black version.

## Eco Plakatständer, doppelseitig |

*Eco Infoboard, double-sided*

- Einreihiger oder zweireihiger Plakatständer, doppelseitig
- Preisgünstig
- Versetzte Einschubrahmen
- Silberfarbig oder schwarz

- *Single-row or double-row poster stand, double-sided*
- *Inexpensive*
- *Slide in poster frame*
- *Silver or black*

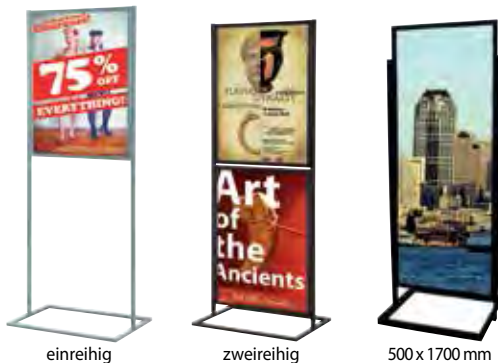

einreihig

zweireihig

500 x 1700 mm

Art.-Nr. Silber	Art.-Nr. Schwarz	Plakatmaß	Beschreibung
UIBS00N1A1X1000	UIBS00C1A1X1000	594 x 841	einreihig
UIBS00N1B2X1000	UIBS00C1B2X1000	500 x 700	einreihig
UIBS00N2A1X1000	UIBS00C2A1X1000	594 x 841	zweireihig
UIBS00N2B2X1000	UIBS00C2B2X1000	500 x 700	zweireihig
UIBS00N1S1X1000	UIBS00C1S1X1000	500 x 1700	einreihig



## Ovalfuß-Plakatständer, doppelseitig |

*Oval Info Board, double-sided*

- Preisgünstiger, doppelseitiger Plakatständer
- Einschubrahmen im Hochformat
- Ovale Fußplatte
- Komplett silberfarbig

- *Economic, double-sided poster stand*
- *Slide-in frame in potrait*
- *Oval base*
- *Silver colored*



H-Fuß Plakatständer optional  
H-Feet Info Board optional



Art.-Nr.	Plakatmaß (mm)
UIBS10N0A2X1000	420 x 594
UIBS10N0A1X1000	594 x 841
UIBS10N0B2X1000	500 x 700

## Vintage Displays, Leuchtschilder und Möbel | *Vintage Displays, Signs and Furniture*



- **Vintage ist ein Lifestyle!**
- Vom Vintage-Stil spricht man, wenn ein Produkt neu ist, aber im „Used-Look“ hergestellt ist. Sprich alt und gebraucht aussieht
- Der Vintage-Stil ist sowohl im privaten Bereich wie auch in der Ladeneinrichtung nicht mehr wegzudenken und ist Trendgeber bei der Entwicklung neuer Produkte
- Finden Sie hier beispielhaft einige Produkte die wir im Vintage Stil umgesetzt haben

### Vintage is a lifestyle!

- *The vintage style is when a product is new, but it is prepared in the "used-look"*
- *The vintage style has become indispensable both in the private sector as well as in the shop interior and is a trendsetter in the design of new products*
- *Here are some examples of some of the products that we have implemented in vintage style*



## Vintage Holzkiste faltbar | *Vintage Foldable Wood Box*

- "Vintage" Holzkiste für Aufbewahrungs- oder Dekozwecke
  - Mahagonifarbenes Pinenholz
  - Tragegriffe aus Hanfstrick
  - Geringes Transportvolumen durch zerlegte Lieferung
  - Einfache, werkzeuglose Montage durch Stecksystem
- *"Vintage" wooden box for storage or decoration*
  - *Pine wood*
  - *Handles made of rope*
  - *Low transport thanks to flat pack*
  - *Easy tool less assembly*



Art.-Nr.	Abmessung (mm)	Farbe
UWFBM01116X2000	279 x 406 x 152	Mahagoni
UWFBM01420X2000	355 x 508 x 203	Mahagoni
UWFBM01432X2000	355 x 812 x 203	Mahagoni
UWFBM01445X2000	355 x 1140 x 203	Mahagoni
UWFBM02050X2000	508 x 1270 x 203	Mahagoni

## Vintage Präsentationsdisplay | *Vintage presentation display*

- Gestell in L-Form aus sägerauem Holz, schwarz lasiert
  - Rahmen auf Bodenfläche zur Fixierung der Kartons
  - 25 mm Klapprahmen für DIN A1 Plakate
  - 4 Laufrollen - davon 2 feststellbar
  - Abmessungen: 780 x 700 x 1800 mm (BxTxH)
  - Stellfläche für Kartons: 710 mm x 310 mm
- *Frame in L-shape made from construction wood, black glazed*
  - *Frame on baseplate for fixing the boxes*
  - *25 mm snap frame for A1 posters*
  - *4 castors - of which 2 are lockable*
  - *Dimensions: 780 x 700 x 1800 mm (WxDxH)*
  - *Storage space for boxes: 710 mm x 310 mm*



Art.-Nr.	Abmessung (mm)	Farbe
1702008	780 x 700 x 1800	schwarz, lasiert



## Verkaufsdisplay NATURE | *Merchandiser NATURE*

- Hochwertiges und sehr stabiles Verkaufsdisplay
- Sperrholz, natur, unbehandelt
- Ideal für den Dauereinsatz geeignet
- Vier Fächer untereinander angeordnet
- Erhältlich in vier verschiedenen Größen
- Einfacher, werkzeugloser Aufbau durch Stecksystem
- Transportgünstig verpackt im Flachkarton

- *High quality and very stable merchandiser*
- *Made of natural plywood, untreated*
- *Ideally suited for long term use*
- *Four compartments arranged one below the other*
- *Available in four different sizes*
- *Easy, tool-free assembly thanks to the plug-in system*
- *Packed in a flat box for low cost transportation*



Art.-Nr.	Farbe	Version	Abmessung (mm)
UWRSUOLO0SX2000	natur	S	240 x 260 x 895
UWRSUOLO0MX2000	natur	M	315 x 335 x 1180
UWRSUOLO0LX2000	natur	L	430 x 475 x 1610
UWRSUOLO0XLX2000	natur	XL	645 x 475 x 1610



## Universeller Schaukasten | Universal Officeboard

- Formschöner, abschließbarer Info Schaukasten für den Inneneinsatz
  - Nutzbare Bautiefe 25 mm
  - Magnetische Stahl-Rückwand und seitliches Schloss
  - Frontscheibe aus schlagfestem PETG
  - Auch erhältlich als Poster-Schaukasten mit PVC-Rückwand
- *Elegant lockable showcase for indoor use*
  - *Construction depth 25 mm*
  - *Magnetic rear panel and side lock*
  - *Front sheet made of impact resistant PETG*
  - *Also available as poster showcase with PVC rear panel*



Art.-Nr.	Format	Ausführung
USBNU000A2X1000	DIN A2	Poster Schaukasten
USBNU000A1X1000	DIN A1	Poster Schaukasten
USBNU000A0X1000	DIN A0	Poster Schaukasten
USBNU204A4X1000	4 x DIN A4 hoch	Info Schaukasten
USBNU206A4X2000	6 x DIN A4 hoch	Info Schaukasten
USBNU209A4X1000	9 x DIN A4 hoch	Info Schaukasten
Art.-Nr.	Beschreibung	
UYUP397000X1000	Magnete	DM = 20 mm, 10er Set
UYUP427510X1000	Ersatzschlüssel	

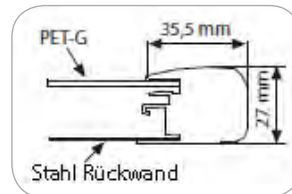

Info Schaukasten

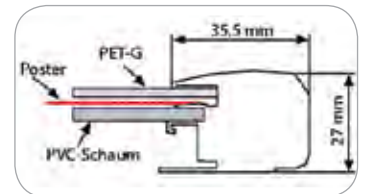

Poster Schaukasten

## Outdoor Schaukasten | Outdoor Showcase

- Abschließbarer Schaukasten für den Außeneinsatz
  - Nutzbare Bautiefe 36 mm
  - Weiße, magnethaftende Rückwand und seitliches Schloss
  - Frontscheibe aus schlagfestem PETG
- *Lockable showcase for outdoor use*
  - *Usable depth 36 mm*
  - *White, magnetic rear panel and side lock*
  - *Front sheet made of impact resistant PETG*

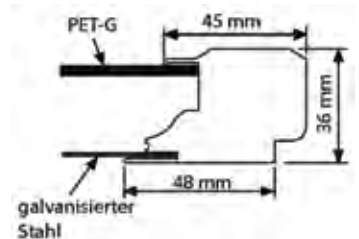

Art.-Nr.	Format
USBN2004A4X1000	4 x A4
USBN2006A4X1000	6 x A4
USBN2009A4X1000	9 x A4
USBN2012A4X1000	12 x A4
Art.-Nr.	Beschreibung
UYUP397000X1000	Magnete, DM = 20 mm, 10er Set
UYUP427510X1000	Ersatzschlüssel

## Indoor Schaukasten | Indoor Officeboard

- Abschließbarer Schaukasten für den Inneneinsatz
- Nutzbare Bautiefe 35 mm
- Weiße, magnethaftende Rückwand und Frontscheibe mit Schloss
- Frontscheibe aus schlagfestem PETG

- Lockable showcase for indoor use
- Usable depth 35 mm
- White, magnetic rear panel and lock in door
- Front sheet made of impact resistant PETG

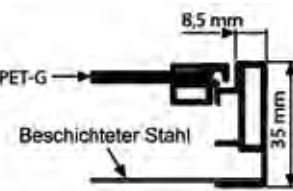
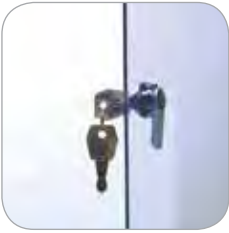

Art.-Nr. Magnethaftend	Format	Sichtmaß (mm)
USBN5004A4X1000	4 x A4	474 x 657
USBN5006A4X1000	6 x A4	474 x 977
USBN5009A4X1000	9 x A4	704 x 977
Art.-Nr.	Beschreibung	
UYUP397000X1000	Magnete	DM = 20 mm, 10er Set
UYUP427510X1000	Ersatzschlüssel	

## Plakat-Schaukasten | Poster Showboard

- Abschließbarer Plakat-Schaukasten für den Außeneinsatz
- Drehflügel mit PETG Frontscheibe
- Plakat wird mit Clipsen fixiert

- Lockable poster-showboard for outdoor using
- Double wing door with PETG sheet
- Poster to be fixed with clips

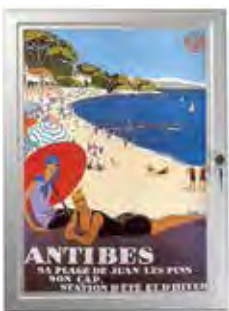

Art.-Nr.	Farbe	Plakatmaß (mm)
USBN0000A3X1000	silber eloxiert	297 x 420
USBN0000A2X1000	silber eloxiert	420 x 594
USBN0000A1X1000	silber eloxiert	594 x 841
USBN0000A0X1000	silber eloxiert	841 x 1189
USBN0000B2X1000	silber eloxiert	500 x 700
USBN0000B1X1000	silber eloxiert	700 x 1000
Art.-Nr.	Bezeichnung	
UYUP427510X1000	Ersatzschlüssel	

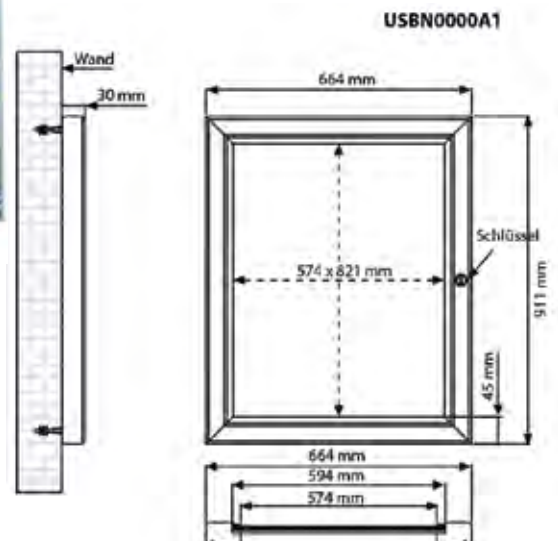
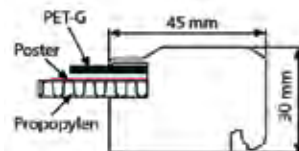

## Glas-Magnettafel | Glass-Magnetic board

- Magnettafel aus Einscheiben-Sicherheitsglas mit Stahleinleger
- Beschreibbar mit handelsüblichem Board Marker
- Trocken abwischbar
- Vorbereitet zur Wandmontage durch verdeckte Schlüsseloch-Aufhängungen
- Magnete, Stifthalter, Wischer und Stift sind im Lieferumfang enthalten
- Erhältlich in rot, schwarz und weiß
- Ablage aus Acrylglas optional

- *Magnetic panel made of tempered safety glass*
- *Writable with standard board marker*
- *Dry-erase*
- *Prepared for wall mounting with concealed keyhole suspensions*
- *Magnets, pen holder, wiper and pen are included*
- *Available in red, black and white*
- *Tray made of acrylic glass optional*

Art.-Nr.	Format (mm)	Farbe
TO0MGB0335X2000	350 x 350	weiß
TO0MGB0135X2000	350 x 350	schwarz
TO0MGB0435X2000	350 x 350	rot
TO0MGB0345X2000	450 x 450	weiß
TO0MGB0145X2000	450 x 450	schwarz
TO0MGB0445X2000	450 x 450	rot
TO0MGB0346X2000	400 x 600	weiß
TO0MGB0146X2000	400 x 600	schwarz
TO0MGB0446X2000	400 x 600	rot
TO0MGB0369X2000	600 x 900	weiß
TO0MGB0169X2000	600 x 900	schwarz
TO0MGB0469X2000	600 x 900	rot

### Zubehör | Accessories

Art.-Nr.	Produkt	Ausführung
UYMGB00000X2000	Ablage	glasklar



Aufhängung | Hangers



Ablage | Shelf



Stifte | Pens



## Holz-Kreidetafel Slide | Wooden Chalkboard Slide

- Holz-Einschubrahmen aus Buchenholz, dunkel lasiert, produziert aus zertifiziertem Holz
- Ideal für die doppelseitige Aktions-Werbung im Schaufenster oder im Lokal
- Mit Standfüßen auch als Regaltopper nutzbar
- Doppelseitig aus MDF
- Einschuböffnung ermöglicht auch den Einsatz als Plakaträhmen
- Kreidetafel beschreibbar und feucht oder nass abwischbar

- *Wooden frame made of certified beech wood, dark lacquered*
- *Double-sided writable chalkboard made of MDF*
- *Slide in opening allows use of other panels*
- *Slide-in frame also suitable for double-sided poster advertising*
- *Writable and moist or wet wipeable*



Plakaträhmen

Art.-Nr.	Format (mm)	Farbe
UWSFD000A4X2000	210 x 297	Buche, dunkel
UWSFD000A3X2000	297 x 420	Buche, dunkel
UWSFD000A2X2000	420 x 594	Buche, dunkel
UWSFD000A1X2000	594 x 841	Buche, dunkel
Art.-Nr.	Beschreibung	Farbe
UYAKLM1251X1000	Kreidestifte 5er Set, 10 mm breit	bunt
UYAKLM1250X1000	Kreidestifte 3er Set, 10 mm breit	weiß



Kreidetafel





## Holz Kreidetafel MEMO | Wooden Chalkboard MEMO

- Kreidetafel aus hellem Buchenholz, produziert aus zertifiziertem Holz
  - Magnethaftende Kreidetafel
  - Ideal für Kreidemarker und Magnete
  - Beschreibbar und feucht oder nass abwischbar
  - Integrierte Stiftablege
- Chalkboard made of certified beech wood, light
  - Magnetic chalkboard
  - Ideal for use of chalk markers and magnets
  - Writable and moist or wet wipeable
  - Integrated shelf



Art.-Nr.	Farbe	Abmessung (mm)
UWNLW0D0F2X2000	Buche, hell	210 x 300
Art.-Nr.	Kreidestifte	Farbe
UYAKLM1251X1000	5 er Set, 10 mm breit	bunt
UYAKLM1250X1000	3 er Set, 10 mm breit	weiß

## Holz-Kreidetafel Buche | Wooden Chalkboard beech

- Angebotstafel für Gastronomie und Hotellerie
  - Optimal für den täglichen Gebrauch dank solidem Vollholz-Rahmen aus Buchenholz, dunkel lasiert, produziert aus zertifiziertem Holz
  - Beschreibbar mit Kreide oder Kreidemarker und feucht abwischbar mit einem Microfaser Tuch
- Chalkboard for gastronomy and hotel industry
  - Solid wood frame made of certified beech wood, dark lacquered
  - Writable with chalk and chalk markers and wet wipeable with a microfibre cloth



Art.-Nr.	Plakatmaß (mm)	
UWSSD10034X5000	300 x 400	
UWSSD10046X5000	400 x 600	
UWSSD10049X5000	400 x 900	
UWSSD10068X5000	600 x 800	
UWSSD10061X5000	600 x 1150	
UWSSD10081X5000	800 x 1200	
Art.-Nr.	Beschreibung	Farbe
UYAKLM1251X1000	Kreidestifte 5er Set, 10 mm breit	bunt
UYAKLM1250X1000	Kreidestifte 3er Set, 10 mm breit	weiß



## Holz-Staffelei | Wooden easel



- Solide Feldstaffelei produziert aus zertifiziertem Buchenholz
- Höhenverstellbar und im Neigungswinkel einstellbar
- Ideal geeignet für Kreide- oder Magnettafeln, Leinwände oder Posterrahmen

- *Solid Easel made of certified beech wood*
- *Height adjustable*
- *Ideally suited for chalkboards or poster frames*



Art.-Nr.	Höhe max   min (mm)
USLA000012X1000	1530   2050

## Holz-Staffelei Economy | Wooden Easel Economy



- Aus hochwertigem Kiefern-Holz, lasiert
- Ideal geeignet für Angebots- oder Werbetafeln aller Art
- Die Halterung für Tafeln ist in 3 Stufen höhenverstellbar
- Erhältlich in natur oder dunkler Holz-Optik

- *Made of high quality pine wood, glazed*
- *Ideal for all kinds of billboards*
- *The holder for panels is height adjustable in 3 steps*
- *Available in natural or dark wood look*



Art.-Nr.	Ausführung	Höhe (mm)
USLBD00016X2000	Holz, dunkel	1595
USLBN00016X2000	Holz, natur	1595

## Holz Info Aufsteller FLOOR | Wooden Info Stand FLOOR

- Freistehende Infotafel aus hellem Kiefernholz
  - Magnethaftendes Whiteboard
  - Ideal für Kreidemarker, Magnete und Infotaschen
  - Klappbare Rückenstütze für stabilen Stand
- Floorstanding info board made of fir wood, nature
  - Magnetic whiteboard
  - Ideal for chalk markers, magnets and magnetic poster pockets
  - Foldable back support for a stable stand



Art.-Nr.	Farbe	Abmessung (mm)
UWDFS0D010X2000	Kiefer, dunkel lasiert	440 x 770
UWDFS0D020X2000	Kiefer, dunkel lasiert	440 x 1020
UWDFS0D030X2000	Kiefer, dunkel lasiert	440 x 1370
Art.-Nr.	Beschreibung	Farbe
UYAKLM1251X1000	Kreidestifte 5er Set, 10 mm breit	bunt



440 x 770 mm



440 x 1020 mm



440 x 1370 mm

## Holz Kreidetafel Aufsteller FLOOR | Wooden Chalkboard FLOOR Stand

- Freistehende Werbetafel aus zertifiziertem Buchenholz, dunkel lasiert
  - Kreidetafel aus MDF
  - Klappbare Rückenstütze für stabilen Stand
  - Mit Kreidemarkern beschreibbar
  - Feucht oder nass abwischbar
- Floorstanding board made of certified beech wood, dark lacquered
  - Foldable back support for a stable stand
  - MDF chalkboard
  - With chalk markers writable
  - Moist or wet wipeable



Art.-Nr.	Farbe	Abmessung (mm)
UWCFSD010X2000	Buche, dunkel	440 x 770
UWCFSD020X2000	Buche, dunkel	440 x 1020
UWCFSD030X2000	Buche, dunkel	440 x 1370
Art.-Nr.	Beschreibung	Farbe
UYAKLM1251X1000	Kreidestifte 5er Set, 10 mm breit	bunt
UYAKLM1250X1000	Kreidestifte 3er Set, 10 mm breit	weiß



440 x 1370 mm



440 x 1020 mm



440 x 770 mm



## Mobile-Staffelei | Mobile Easel



- Mobile Staffelei aus Metall oder Holz
- Erhältlich in silber, schwarz oder Buche natur
- Ausstellfüße zusammenklappbar
- Ideal für Restaurants, Boutiquen, Kunstgalerien und Schulen

- Mobile easel made of steel
- Available in black or silver coloured or beech wood natural
- Folding feet collapsible
- Suitable for restaurants, art galleries or classrooms



Ausführung in schwarz  
Version in black



Ausführung in Buche natur  
Version in beech wood natural



Ausführung in grau  
Version in grey



Nylon-Trageköcher  
Nylon carrying case

Art.-Nr.	Höhe (mm)	Farbe
UPESLOG015X1000	1500	Grau
UPESLOB015X1000	1500	Schwarz
UWPESLN010X2000	1500	Buche
Art.-Nr.	Beschreibung	
UYUP067400X5001	Nylon-Trageköcher für Mobile Staffelei	
3252014	Poster DIN A1 "Abstand halten"	



## Gesichtsschutz-Visier | Hygienic Mask

- Mobiler Schutz für das Verkaufspersonal im Shop oder der Filiale
  - Vollschutz über den gesamten Gesichtsbereich
  - Einfaches Handling durch verstellbares Band mit Kopfpolster
  - Lebensmittelechtes PET – beschlägt nicht und ist wasser- und staubfest
  - Problemlos nutzbar auch für Brillenträger
  - Unkomplizierte Reinigung mit herkömmlichen Reinigungsmitteln
  - **Qualität Made in Europe**
- *Mobile protection for sales staff in shop and store*
  - *Covers entire face*
  - *Flexible and adjustable belt helps visor fitting the head comfortably*
  - *PET, suitable for food contact and is water- and dust-proof*
  - *Suitable for use with glasses*
  - *Simple to clean. PET can be cleaned by regular cleaners and sanitizers*
  - **Quality Made in Europe**



Auf Anfrage mit Logo-Druck  
On request with Logo-print



Art.-Nr.	Format (mm)
UYHM000010X2000*	284 x 353 x 0,5

\* Technische Änderungen vorbehalten!  
\* Technical changes reserved!

\*\* Sammelverpackung zu 50 Stück - Mehrpreis Einzelverpackung.  
\*\* Collective packaging of 50 pieces - additional price for single packaging.



## Desinfektionsständer Variation OUTDOOR | Sanitizer Station Variation OUTDOOR



- Sehr standfester Desinfektionsständer für den Outdoor Einsatz
- Gestell aus robustem Metall-Profil, silberfarbig
- Mobil durch Bodenplatte mit integrierten Laufrollen
- Wasserfester Klapprahmen im DIN A3 Format
- Ellbogen Liquid-Spender mit Nachfüll-Flasche, 1000 ml
- Abtropfschale aus Metall und Plexiglas
- Transportfähige Verpackung

- *Sturdy disinfection station for protected outdoor use*
- *Made of metal, silver colored*
- *Mobile thanks to base plate with wheels*
- *Central upright allows height adjustment of dispenser*
- *Dispenser with refillable 1000 ml bottle*
- *Sanitizer dispenser for 1000 ml bottle, made of grey plastic*
- *Comes with drip tray*
- *Individually packed in carton*



\* Technische Änderungen vorbehalten! Die Pumpe des Dispensers ist ein Verschleißteil und unterliegt nicht der Gewährleistung!  
 \* Technical changes reserved! The pump of the dispenser is a wearing part and it is not subject of the guarantee!

Art.-Nr.	Abmessungen (mm)
1604023*	400 x 1700 x 400

## Desinfektionsständer BOND Outdoor 2 |

*Sanitizer Station BOND Outdoor 2*

- Desinfektionsständer für den überdachten Outdoor Einsatz
- Säule aus 4 mm starker Alu-Verbundplatte, weiß
- Abmessung: 200 x 1250 mm
- Säule rückseitig zur Stabilisierung mit Alu-Profil verschraubt
- Bodenplatte aus Stahl mit dekorativer Abdeckung aus weißer Alu-Verbundplatte
- Abmessung Bodenplatte: 300 x 400 mm
- Höhenverstellbare Füße
- Desinfektionsmittel-Spender für 1.000 ml (Desinfektionsmittel muss manuell nachgefüllt werden, die Pumpe des Dispensers ist ein Verschleißteil und unterliegt nicht der Gewährleistung!)
- Transportfähige Verpackung, Gewicht 10 kg
- Made in Germany

- *Disinfection stand for outdoor use*
- *Panel made of white 4 mm aluminium composite sheet*
- *Size 200 x 1250 mm with rear stabilizer*
- *Base 300 x 400 mm made of steel with white aluminium composite cover*
- *Height adjustable feet*
- *Sanitizer dispenser with 1000 ml tank, made of grey plastic (Sanitizer must be refilled manually, the pump of the dispenser is a wearing part and it is not subject of the guarantee!)*
- *Individually packed in carton, Weight 10 kg*
- *Made in Germany*



Art.-Nr.	Abmessungen (mm)
1604029*	300 x 400 x 1300

\* Technische Änderungen vorbehalten!  
 \* Technical changes reserved!

## Desinfektionsständer BOND NoTouch |

*Sanitizer Station BOND NoTouch*

- Desinfektionsständer für den überdachten Outdoor Einsatz
- Säule aus 4 mm starker Alu-Verbundplatte, weiß
- Abmessung: 200 x 1250 mm
- Säule rückseitig zur Stabilisierung mit Alu-Profil verschraubt
- Bodenplatte aus Stahl mit dekorativer Abdeckung aus weißer Alu-Verbundplatte
- Abmessung Bodenplatte: 300 x 400 mm
- Höhenverstellbare Füße
- Sensor Liquid Dispenser mit 1000 ml Nachfüll-Tank (OHNE Batterien)
- Integrierte Tropfschale
- Transportfähige Verpackung, Gewicht 10 kg
- Made in Germany

- *Disinfection stand for outdoor use*
- *Panel made of white 4 mm aluminium composite sheet*
- *Size 200 x 1250 mm with rear stabilizer*
- *Base 300 x 400 mm made of steel with white aluminium composite cover*
- *Height adjustable feet*
- *Sensor sanitizer dispenser with 1000 ml refill tank (WITHOUT Batteries) and integrated drip tray*
- *Individually packed in carton, Weight 10 kg*
- *Made in Germany*

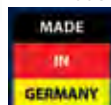

Art.-Nr.	Abmessungen (mm)
1604038*	300 x 400 x 1300

\* Technische Änderungen vorbehalten!  
 \* Technical changes reserved!

## Desinfektionsständer WOOD Indoor 2 |

Sanitizer Station WOOD Indoor 2

- Desinfektionsständer für den Indoor Einsatz
- Gestell aus kunststoff-beschichtetem Holz, weiß
- Säule aus 19 mm starkem Material, 200 x 1250 mm
- Bodenplatte aus 38 mm Material, 250 x 300 mm
- Desinfektionsmittel-Spender für 1.000 ml (Desinfektionsmittel muss manuell nachgefüllt werden, die Pumpe des Dispensers ist ein Verschleißteil und unterliegt nicht der Gewährleistung!)
- Demontierte Lieferung mit einfacher Aufbauanleitung
- Gewicht 7 kg
- Made in Germany

- *Desinfection stand for indoor use*
- *Frame made of plastic-coated wood, white*
- *Panel size 200 x 1250 mm, 19 mm thickness*
- *Base size 250 x 300 mm, 38 mm thickness*
- *Sanitizer dispenser with 1.000 ml tank, made of grey plastic (Disinfectant must be refilled manually, the pump of the dispenser is a wearing part and it is not subject of the guarantee!)*
- *Disassembled delivery with simple assembly*
- *Weight: 7 kg*
- *Made in Germany*



Art.-Nr.	Abmessungen (mm)
1604030*	250 x 300 x 1250

\* Technische Änderungen vorbehalten!  
\* Technical changes reserved!

## Desinfektionsständer WOOD NoTouch |

Sanitizer Station WOOD NoTouch

- Desinfektionsständer für den Indoor Einsatz
- Gestell aus kunststoff-beschichtetem Holz, weiß
- Säule aus 19 mm starkem Material, 200 x 1250 mm
- Bodenplatte aus 38 mm Material, 250 x 300 mm
- Sensor Liquid Dispenser mit 1000 ml Nachfüll-Tank (OHNE Batterien)
- Integrierte Tropfschale
- Demontierte Lieferung mit einfacher Aufbauanleitung
- Gewicht 7 kg
- Made in Germany

- *Desinfection stand for indoor use*
- *Frame made of plastic-coated wood, white*
- *Panel size 200 x 1250 mm, 19 mm thickness*
- *Base size 250 x 300 mm, 38 mm thickness*
- *Sensor sanitizer dispenser with 1000 ml refill tank (WITHOUT Batteries) and integrated drip tray*
- *Disassembled delivery with simple assembly instructions*
- *Weight: 7 kg*
- *Made in Germany*



Art.-Nr.	Abmessungen (mm)
1604040*	250 x 300 x 1250

\* Technische Änderungen vorbehalten!  
\* Technical changes reserved!

## Desinfektionsständer WOOD PLUS | Sanitizer Station WOOD PLUS

- Kombierter Desinfektionsständer für den Indoor Einsatz
- Gestell aus weißer, Melamin beschichteter Spanplatte mit 2 mm ABS Kante umleimt
- Spezial Bodengleiter zum perfekten Schutz von allen Bodenbelägen
- Säule aus 19 mm starkem Material, Abmessung 300 x 1500 mm
- Bodenplatte aus 38 mm Material, Abmessung 320 x 350 mm
- Desinfektionsmittel-Spender mit 1000 ml Flasche
- Ablage mit Tropfschale aus Edelstahl
- DIN A4 Klapprahmen für Kunden-Informationen
- Transportfähige Verpackung

- *Combined sanitizer station for indoor use*
- *Stand made of white, melamine-coated chipboard with 2 mm ABS edging*
- *Special floor glides for perfect protection of all floor coverings*
- *Column made of 19 mm thick material, dimensions 300 x 1500 mm*
- *Base plate made of 38 mm material, dimensions 320 x 350 mm*
- *Disinfectant dispenser for 1000 ml, plastic*
- *Storage with stainless steel drip tray*
- *A4 folding frame for customer information*
- *Transportable packaging*



Art.-Nr.	Abmessungen (mm)
1604022*	300 x 1500 x 350

\* Technische Änderungen vorbehalten! Die Pumpe des Dispensers ist ein Verschleißteil und unterliegt nicht der Gewährleistung!  
\* Technical changes reserved! The pump of the dispenser is a wearing part and it is not subject of the guarantee!



## Desinfektionsständer WOOD Premium | Sanitizing Station WOOD Premium



- Attraktiver Desinfektionsständer für den Indoor Einsatz
- Gestell aus weiß kunststoff-beschichtetem Holz
- Säule aus 19 mm starkem Material, Abmessung 200 x 1250 mm
- Bodenplatte aus 38 mm Material, Abmessung 250 x 300 mm
- Desinfektionsmittel-Spender für 1000 ml, Kunststoff, mit Auffangschale
- Ablage mit Tropfschale aus Edelstahl
- Transportfähige Verpackung

- *Stylish sanitizer station for indoor use*
- *Made of white plastic coated wood*
- *Upright panel size 200 x 1250 mm, 19 mm thickness*
- *Base size 250 x 300 mm, 38 mm thickness*
- *Sanitizer dispenser with refillable 1000 ml bottle, made of plastic*
- *Shelf with drip tray made of stainless steel*
- *Individually packed in carton*



Art.-Nr.	Abmessungen (mm)
1604018*	250 x 300 x 1250

\* Technische Änderungen vorbehalten! Die Pumpe des Dispensers ist ein Verschleißteil und unterliegt nicht der Gewährleistung!

\* Technical changes reserved! The pump of the dispenser is a wearing part and it is not subject of the guarantee!



## Desinfektionsständer VINTAGE |

Sanitizing Station VINTAGE

- Moderner Desinfektionsständer im VINTAGE Look
- Bodenplatte (Ø 350mm) & Halter aus hochwertigem Eichenholz
- Zentralprofil aus schwarz pulverbeschichtetem Stahl
- Ellbogen Liquid Spender mit 1000 ml Nachfüll-Tank
- Gesamthöhe 1250 mm
- Demontierte Lieferung in transportfähiger Verpackung
- Qualität Made in Germany

- *Modern sanitizer station in VINTAGE look*
- *Base plate (Ø 350 mm) and holder made of high quality oak wood*
- *Central profile made of black powder-coated steel*
- *Elbow liquid dispenser with 1000 ml refill tank*
- *Overall height 1250 mm*
- *Comes knocked down in transportworthy packing*
- *Quality Made in Germany*



Art.-Nr.	Abmessungen (mm)
1604024*	350 x 350 x 1250

\* Technische Änderungen vorbehalten!  
Die Pumpe des Dispensers ist ein Verschleißteil und unterliegt nicht der Gewährleistung!

\* Technical changes reserved!

The pump of the dispenser is a wearing part and it is not subject of the guarantee!

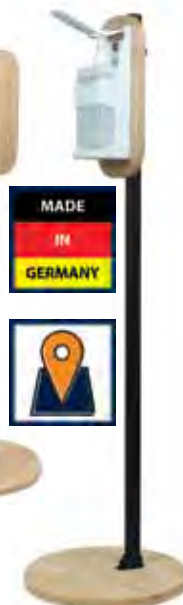

## Desinfektionsständer VINTAGE NoTouch |

Sanitizing Station VINTAGE NoTouch

- Moderner Desinfektionsständer im VINTAGE Look
- Bodenplatte (Ø 350mm) & Halter aus hochwertigem Eichenholz
- Zentralprofil aus schwarz pulverbeschichtetem Stahl
- Sensor Liquid Dispenser mit 1000 ml Nachfüll-Tank (OHNE Batterien)
- Integrierte Tropfschale
- Gesamthöhe 1250 mm
- Qualität Made in Germany

- *Modern sanitizer station in VINTAGE look*
- *Base plate (Ø 350 mm) and holder made of high quality oak wood*
- *Central profile made of black powder-coated steel*
- *Sensor sanitizer dispenser with 1000 ml refill tank (WITHOUT Batteries) and integrated drip tray*
- *Overall height 1250 mm*
- *Comes knocked down in transportworthy packing*
- *Quality Made in Germany*



Art.-Nr.	Abmessungen (mm)
1604039*	350 x 350 x 1250

\* Technische Änderungen vorbehalten!

\* Technical changes reserved!





## Desinfektionsständer Budget | Sanitizing Station Budget

- Hygiene Station als Bausatz für kostengünstigen Transport
  - Stabile Bodenplatte aus Stahl, RAL 9006
  - Elliptisches Zentralprofil mit Systemnuten
  - Erhältlich in 3 Standard-Ausführungen:
    - DIN A3 Informaten im Hochformat mit Ellbogen Liquid-Dispenser
    - Gestell mit Halterung und Klett-/ Flauschbändern für Liquid-Spender
    - Gestell mit Box für Latex Handschuhe oder Masken
  - Perfekt geeignet für alle öffentlichen Bereiche
  - Demontierte Lieferung mit einfacher Aufbauanleitung
- 
- *Sanitizer station as a kit for inexpensive transportation*
  - *Stable base plate made of steel, RAL 9006*
  - *Elliptical central profile with system grooves*
  - *Available in 3 standard versions:*
    - *DIN A3 information frame in portrait format with elbow liquid dispenser*
    - *Stand with holder and velcro straps for liquid dispensers*
    - *Stand with box for latex gloves or masks*
  - *Perfectly suited for all public areas*
  - *Disassembled delivery with simple assembly instructions*

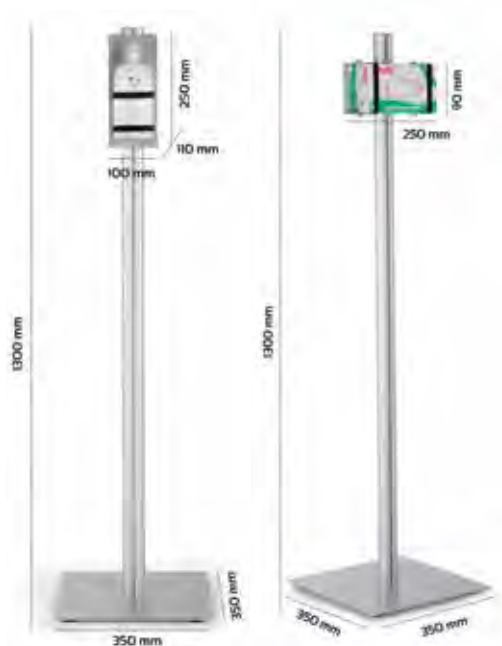
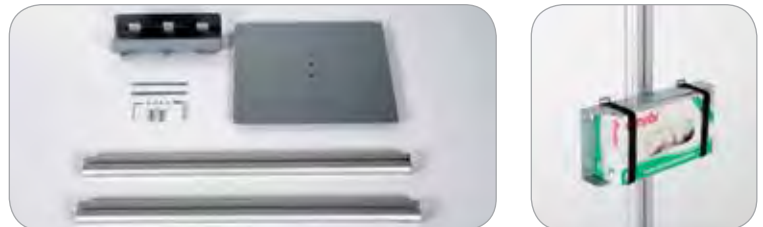

Art.-Nr.	Ausführung	Abmessungen (mm)
USSAON2A02X5000*	Ständer mit DIN A3 Klapprahmen und Ellbogen Liquid-Spender	350 x 1650 x 350
1604019*	Ständer mit Ablage für Liquid-Spender	350 x 1300 x 350 / 100 x 250 x 110
1604020*	Ständer mit Halter für Latex-Handschuhe oder Masken	350 x 1300 x 350 / 250 x 90 / 150 x 50

\* Technische Änderungen vorbehalten! Die Pumpe des Dispensers ist ein Verschleißteil und unterliegt nicht der Gewährleistung!

\* Technical changes reserved! The pump of the dispenser is a wearing part and it is not subject of the guarantee!

## Desinfektionsständer FOOT BASIC | BASIC Touchless Dispenser Stand



- Desinfektionsständer für den Innen- oder Outdoor-Einsatz
- Stabile Stahl-Zentralsäule, RAL 9006
- Standfeste Bodenplatte mit Bodengleitern
- Desinfektionsmittel Spender mit 1000 ml Flasche und Tropfschale
- Betätigung durch Fußpedal garantiert hautkontaktlose, hygienische Spende
- Optional mit Header für permanentes Branding

- Sanitizing station for in- and outdoor use
- Sturdy steel upright, RAL 9006
- Base plate with floor gliders
- Liquid dispenser with 1000 ml tank and drip tray
- Operation by foot pedal guarantees skin-free, hygienic dispensing
- Header for permanent branding optionally



Art.-Nr.	Ausführung
UHTDBG2000X2000*	Silberfarbig RAL 9006, 1000 ml Dispenser
UYPHDB010X2000	Top-Schild 250 x 350 mm

\* Technische Änderungen vorbehalten! Die Pumpe des Dispensers ist ein Verschleißteil und unterliegt nicht der Gewährleistung!

\* Technical changes reserved! The pump of the dispenser is a wearing part and it is not subject of the guarantee!

## Desinfektionsständer FOOT VARIO | Sanitizer Station FOOT VARIO



- Desinfektionsständer für den Innen – oder überdachten Outdoor-Einsatz
- Stabile Stahl-Innenkonstruktion
- Säule aus Stahlblech, RAL 9006 pulverbeschichtet
- Bodenplatte mit Laufrollen für mobilen Einsatz
- Desinfektionsmittel Spender mit 1000 ml Flasche und Tropfschale
- Spender in der Höhe verstellbar von 970 bis 1225mm auch für die Nutzung in Schulen und Kindergärten geeignet
- Betätigung durch Fußpedal garantiert hautkontaktlose, hygienische Spende
- Abmessung 370 x 1490 x 400 mm

- Sanitizing station for in- and outdoor use
- Sturdy internal steel construction
- Column made of steel, RAL 9006 powder-coated
- Base plate with castors for mobile use
- Liquid dispenser with 1000 ml tank and drip tray
- Dispenser adjustable in height from 970 to 1225mm, also suitable for use in schools and kindergartens
- Operation by foot pedal guarantees skin-free, hygienic dispensing
- Dimensions 370 x 1490 x 400 mm



Art.-Nr.	Ausführung	Gewicht (kg)
UHTDSG2000X2000	Silberfarbig, 1000 ml Dispenser	12,5

\* Technische Änderungen vorbehalten! Die Pumpe des Dispensers ist ein Verschleißteil und unterliegt nicht der Gewährleistung!

\* Technical changes reserved! The pump of the dispenser is a wearing part and it is not subject of the guarantee!

## Roll Up Budget Trennwandsystem | Roll Up Budget partition system

- Rolldisplay als kostengünstige Trennwand
- Mit eingelegtem, klarsichtigem Banner
- Stabiler Stand durch zwei Stellfüße
- Nylon-Tragetasche mit Trageriemen
- Competitive Roll-Up display separator
- Clear banner
- Stable stand thanks two adjustable feet
- Nylon-bag with shoulder strap

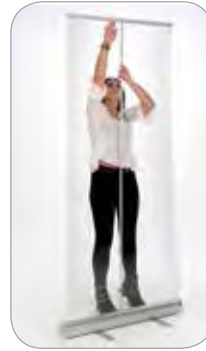

Art.-Nr.	Format (mm)
1604037*	850 x 2000

\* Technische Änderungen vorbehalten!  
\* Technical changes reserved!

## Ellbogen Liquid Dispenser | Elbow Liquid Dispenser

- Liquid Dispenser mit 1 Liter Nachfüll-Flasche
- Nutzbar als Wandmodell oder zum Anbau an Desinfektions-Stationen
- Aus weißem Kunststoff
- Liquid dispenser with 1 liter refill bottle
- Can be used as a wall model or for installation to Sanitizer Stations
- Made of white plastic



Art.-Nr.	Ausführung
1011634H000*	Liquid Dispenser mit 1 Liter Nachfüll-Flasche

\* Technische Änderungen vorbehalten! Die Pumpe des Dispensers ist ein Verschleißteil und unterliegt nicht der Gewährleistung!  
\* Technical changes reserved! The pump of the dispenser is a wearing part and it is not subject of the guarantee!

## Design Desinfektionsspender mit Sensor und Tropfschale | Design Sanitizer Station with Sensor and drip tray

Design Sanitizer Station with Sensor and drip tray

- Spender für: Gel, Flüssigkeit oder Schaum
- Material: ABS-Kunststoff, Polypropylen
- Farbe Elfenbein-weiß
- Maximale Hygiene ohne Berührung - Kontaktlos
- Sprühfunktion 2-stufig einstellbar
- Bei Flüssigkeit feiner, großflächiger Sprühnebel
- Zur Wandmontage geeignet
- Maße: 15 x 12 x 43 cm
- Gewicht: 1,5 kg
- Batteriebetrieb: 4 x AA

- Dispenser suitable for gel, liquid or foam
- Made off ABS plastic and polypropylene
- Color white
- Maximum hygiene without contact
- Spray function adjustable in 2 stages
- Fine, large-area spray mist for liquids
- Suitable for wall mounting
- Dimensions: 15 x 12 x 43 cm
- Weight: 1.5kg
- Battery operation: 4 x AA



Art.-Nr.	Abmessungen (mm)
2900009*	15 x 12 x 43

## Tischmitte Klemmhalter / Tischtrennwand | Mid-Section Clamp Kit / Table partition



- Klemmhalter einfach und werkzeuglos zu montieren und demontieren für anderweitige Nutzung
- Universell nutzbar für alle Plattenmaterialien in Stärken von 2 bis 8 mm
- Platzsparende Befestigung für Trennwände und Hygieneschutz-Wände
- Mit 6 mm Acrylzuschnitt als komplette Tischtrennwand erhältlich
- *Clamp Kit easy and toolless installation and remounting*
- *Universally usable for all rigid panels in thicknesses from 2 to 8 mm*
- *Space-saving fastening for partition walls and hygiene protection walls*
- *Available with 6 mm acrylic glass cut as a complete table partition*

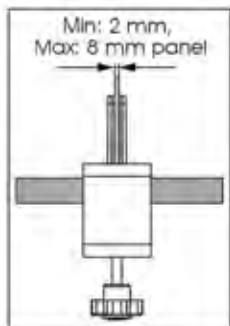
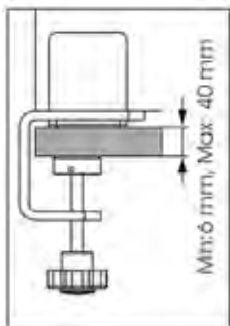

Art.-Nr.	Ausführung	Format   Stärke
UHMCOG0000X2000*	Klemmen-Set (2 Stk)	2-8 mm
1604033*	Klemmen-Set mit Acrylscheibe	700 x 800   6 mm
1604034*	Klemmen-Set mit Acrylscheibe	700 x 1000   6 mm

\* Technische Änderungen vorbehalten!  
\* Technical changes reserved!



## Tischkante Klemmhalter / Tischtrennwand | Edge Clamp Kit/ Table partition

- Klemmhalter einfach und werkzeuglos zu montieren und demontieren für anderweitige Nutzung
- Universell nutzbar für alle Plattenmaterialien in Stärken von 2 bis 8 mm
- Ideal geeignet mit klarem Plexiglas für Spuckschutz-Wände, mit gefrostetem Plexiglas für Trennwände oder mit Tafellack-Panel als Menüboard
- Mit 6 mm Acrylzuschnitt als komplette Tischtrennwand erhältlich
- *Clamp Kit easy and toolless installation and remounting for other application*
- *Universally usable for all plate materials in thicknesses from 2 to 8 mm*
- *Ideally usable with clear plexiglass for spit protection walls, with frosted plexiglass for partitions or with blackboard panel as a menu board*
- *Available with 6 mm acrylic glass cut as a complete table partition*

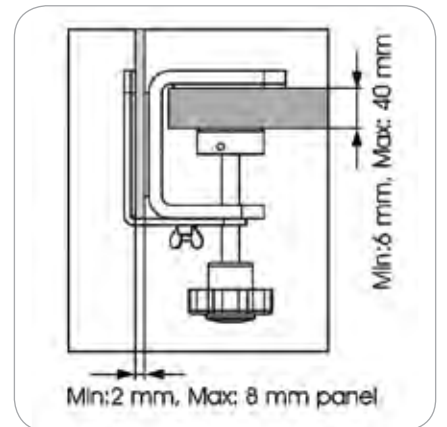

Art.-Nr.	Ausführung	Format   Stärke
UHECOG0000X2000*	Klemmen-Set (2 Stk)	2-8 mm
1604035*	Klemmen-Set mit Acrylscheibe	700 x 800   6 mm
1604036*	Klemmen-Set mit Acrylscheibe	700 x 1000   6 mm

\* Technische Änderungen vorbehalten!  
\* Technical changes reserved!

## NEU! Wand- und Decken Klemmhalter | Wall- and Ceiling clamp kit



- Idealer Klemmhalter für Werbung oder Beschilderung an Wand oder Decke
  - Universell nutzbar für alle Plattenstärken von 2-8 mm
  - Vorbereitet zur Montage mit Bohrungen im Flansch
  - Set bestehend aus 2 Klemmen
- *Ideal clamp holder for advertising or signage on wall or ceiling*
  - *Universally usable for all panel thicknesses from 2-8 mm*
  - *Pre drilled for mounting by holes in the flange*
  - *Set consisting of 2 clamps*



Version Decke  
Version ceiling



Version Wand  
Version wall



Art.-Nr.	Ausführung	Format   Stärke
UHU COG0000X2000	Klemmen-Set (2 Stk)	2-8 mm

## Trennwandsystem MaxiFrame 50 | Partition wall MaxiFrame 50



- Trennwandelement bestehend aus mobilem Aluminium-Kederrahmen und 2 Flachfüßen
  - Zu einem späteren Zeitpunkt können die Trennwände einfach als doppelseitiger, dekorativer Textilspannrahmen genutzt werden
  - Banner vollflächig aus flexiblem und kratzfestem 0,2 mm TPU Material mit 9 mm Flachkeder konfektioniert
  - Standardformate 500 x 2250 mm und 1000 x 2000 mm - Andere Formate auf Anfrage
- *Partition wall consisting of a mobile aluminum textile-frame and 2 flat feet*
  - *Afterwards the partition walls can simply be used and redesigned as a double sided decorative textile stretching frame*
  - *Banner made full area of flexible and scratch resistant 0.2 mm TPU material finished with a 9 mm silicone lip*
  - *Sizes 500 x 2250 mm and 1000 x 2000 mm - Other sizes on request*



Art.-Nr.	Abmessung (mm)
1604031*	500 x 2250
1604032*	1000 x 2000

\* Technische Änderungen vorbehalten!  
\* Technical changes reserved!

## Personenleitsystem VarioBelt Indoor | Control Systems VARIO Belt Indoor

- **Absperreffposten:**
  - Stabiler Gurtpfosten in schwarz mit 4-Wege Anschluss
  - **Gurtlänge 4 m - Spart Pfosten!**
  - Gurt erhältlich in rot, schwarz, gelb, blau, grün, weiß, grau
  - Optional erhältlich als Top-Schild Version
- **Wandkassette:**
  - Gurtkassette schwarz
  - **Gurtlänge 4 m**, verschiedene Farben erhältlich
- **Wandhalterung:**
  - Wandhalterung zum Einclippen von Gurtendstücken
- Made in Europe
- Personalisierung von Gurten möglich, Gurtbreite: 50 mm, max. Höhe für den Druck: 44 mm
- **Barrier post:**
  - Metall post in black colour with 4-way connection
  - Belt available in **4 m length** and in different colours (red, black, yellow, blue, green, white and grey)
  - Optional sign holder for information signs
- **Wall belt case:**
  - Black belt case
  - Belt available in **4 m length** and different colours
- **Wall bracket:**
  - Wall bracket for clipping in strap end pieces
- Made in Europe
- Belts can be individually printed on request  
Belt width: 50 mm, max. High for print: 44 mm



Top-Schild Aufsatz  
Top-Sign Adapter



Wandhalterung  
Wall bracket



Absperreffposten  
Barrier post



Wandkassette  
Wall belt case



Pfosten ohne Gurtkassette  
Barrier post without case



Personalisierung vom Gurt möglich  
Belts can be individually printed



Art.-Nr.	Ausführung	Gurtfarbe	Gurtlänge (mm)
2900001	Pfosten, Bodenplatte und Gurtkassette 4m in schwarz	rot	4000
2900002	Personenleitsystem Wandmodell, Kassette in schwarz	rot	4000
2900092	Pfosten, schwarz, ohne Gurtkassette		
2900003	Personenleitsystem Wandhalterung in schwarz		
2900011	Halter für Infoschild, schwarz, Acrylschild DIN A4 hoch		
2900012	Halter für Infoschild, schwarz, Acrylschild DIN A4 quer		

## NEU! Absperssystem VarioBelt Outdoor | Barrier System VARIO Belt Outdoor

- Stabiler Gurtpfosten in rot, gelb, schwarz
- Gurt aus Textil- oder plastifiziertem Textilband
- Gurtfarbe rot/weiß, gelb/schwarz, schwarz oder rot
- **Gurtlänge: 5 m, 7 m oder 9 m**
- Schwere Bodenplatte in schwarz mit Fußgleitern
- Mit Adapter als Aufsatz kann auch ein Leitkegel als Pfosten genutzt werden
- Personalisierung durch Druck des Gurtes möglich, Gurtbreite: 50 mm, max. Höhe für den Druck: 44 mm
- Made in Europe



- *Barrier post in red, yellow or black colour*
- *Textile or plasticized textile belts available*
- *Belt colour: red/white, yellow/black or black or red*
- **Belt length: 5 m, 7 m or 9 m**
- *Heavy base plate in black with foot gliders*
- *With adapter as an attachment, a traffic cone can also be used as a barrier post*
- *Belts can be individually printed on request, Belt width: 50 mm, max. High for print: 44 mm*
- *Made in Europe*



Personalisierung vom Gurt möglich  
Belts can be individually printed



Gurtkassetten ohne Gurt  
Cases without belt



Gurt und Pfosten in rot & rot/weiß  
Belt and barrier post in red & red/white



Art.-Nr.	Ausführung	Gurtfarbe	Gurtlänge (m)	Gurt
2900017	Gurtkassette, rot	rot-weiß	5	plastifiziert
2900024	Gurtkassette, gelb	gelb-schwarz	5	plastifiziert
2900056	Gurtkassette, rot	rot-weiß	9	plastifiziert
2900063	Gurtkassette, gelb	gelb-schwarz	9	plastifiziert
2900074	Gurtkassette, rot	rot-weiß	7	Textil
2900081	Gurtkassette, gelb	gelb-schwarz	7	Textil
2900053	Gurtkassette rot   ohne Gurt			
2900054	Gurtkassette gelb   ohne Gurt			
2900055	Gurtkassette schwarz   ohne Gurt			
Art.-Nr.	Ausführung	Farbe	Abmessung (mm)	
2900098	Absperreffposten	rot	810	
2900099	Absperreffposten	rot	810	
2900101	Fußplatte	schwarz	380 x 380	
2900104	Konischer Adapter für Leitkegel	schwarz		
2900105	Schnell Adapter	schwarz		
2900106	Wandhalterung	schwarz		
2900107	Wandclip	schwarz		
2900110	Infoschild-Halter	schwarz		
2900114	Acryl Postertasche	transparent	210 x 297	

## Alu-Falttheke Midsize mit Hygieneschutz-Aufsatz | Aluminium counter with clear top-barrier

- **Die All-In-One Promotiontheke**
  - Konvex gewölbte Alu-Falttheke mit Hygieneschutzwand
  - Deckplatte und Zwischenboden weiß
  - Aufsatzrahmen aus Aluminium mit glasklarer 1 mm
  - PET Scheibe im Format: 620 x 720 mm\*
  - Durchreiche in der Höhe verstellbar von 0-180 mm
  - Äußere Systemnuten am Aluprofil ermöglichen die variable Nutzung von Zubehör
  - Gesamthöhe 1820 mm\*
  - Inkl. Transporttasche
  - Unkomplizierte Reinigung mit herkömmlichen Reinigungsmitteln
  - Div. Zubehör wie Liquid Spender optional erhältlich
- **Ready-made counter solution**
  - Outward curved Aluminium counter with clear top-barrier
  - White top plate and shelf
  - Sturdy aluminium frame keeps clear panel stable
  - PET Sheet format: 620 x 720 mm\*
  - Document opening from 0-180 mm adjustable
  - Inbuilt exterior system grooves in frame profile allow variable use of accessories
  - Total height 1820 mm\*
  - Comes with transport bag
  - Simple to clean. PET can be cleaned by regular cleaners and sanitizers
  - Various accessories like Liquid Dispensers are optionally available



Deckelplatte in weiß.  
White top plate.



Deckelplatte in Buche auf Anfrage.  
Plate in beech on request.



Art.-Nr.	Ausführung
UHPCN1100X2000	Weißer Deckelplatte, Hygiene Aufsatz, Transporttasche
UHPCN2100X2000	Buche Deckelplatte, Hygiene Aufsatz, Transporttasche
UHOSG5000X2000	Halter für Liquid-Spender
UHOSG6000X2000	Flexibler Halter für Masken oder Handschuhe
UHOSG2000X2000	Liquid Dispenser 1000 ml



\* Technische Änderungen vorbehalten!  
\* Technical changes reserved!



## Desktop Hygienewand | Desktop Hygienic Protection

- Hygienewand aus Plexiglas für 3-seitigen Schutz
  - Spuckschutz für Kunden und Mitarbeiter
  - Freistehend für Tisch oder Theke
  - Format: 740 x 900 x 170 mm
  - 100 mm hohe Durchreiche für Produkte, Dokumente oder Zahlungsmittel
  - Sofort nutzbar ohne Montage
  - Flexibel einsetzbar durch integrierte Standfüße
- *Hygiene separator made acrylic glass for 3 sided protection*
  - *Spit protection for customers and employees*
  - *Freestanding for table or counter*
  - *Size: 740 x 900 x 170 mm*
  - *Pass-through for products, documents or means of payment*
  - *Can be used out of the box without assembly*
  - *Flexible use thanks to integrated feet*



Art.-Nr.	Abmessung (mm)
1604007*	740 x 900 x 170

\* Technische Änderungen vorbehalten!  
\* Technical changes reserved!

## Desktop Hygienewand Economy | Desktop Hygienic Protection Economy

- Hygienewand aus hochwertigem Plexiglas
  - Spuckschutz für Kunden und Mitarbeiter
  - Freistehend für Tisch oder Theke
  - Format: 700 x 900 x 300 mm
  - 200 mm hohe Durchreiche für Produkte, Dokumente oder Zahlungsmittel
  - Sofort nutzbar ohne Montage
  - Flexibel einsetzbar durch integrierte Standfüße
  - Unkomplizierte Reinigung mit herkömmlichen Reinigungsmitteln
- *Hygiene separator made of plexiglass*
  - *Spit protection for customers and employees*
  - *Freestanding for table or counter*
  - *Size: ~700 x 900 x 300 mm*
  - *200 mm high pass-through for products, documents or means of payment*
  - *Can be used out of the box without assembly*
  - *Flexible use thanks to integrated feet*
  - *Simple to clean. PET can be cleaned by regular cleaners and sanitizers*

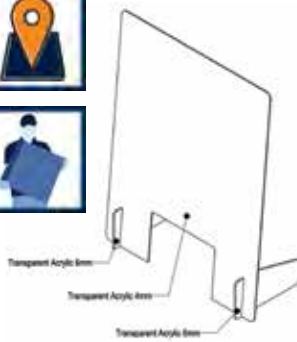

Art.-Nr.	Abmessung (mm)
UHS1090700X5002*	700 x 900 x 300

\* Technische Änderungen vorbehalten!  
\* Technical changes reserved!



## Counter Hygienewand WOOD | Counter Hygienic Protection WOOD



### Der perfekte Spuckschutz für Kunden und Mitarbeiter!

- Hygienewand aus Buchenholz, dunkel lasiert
- Freistehend für Tisch oder Theke
- Schalllöcher für klare Kommunikation
- Durchreiche für Produkte, Dokumente oder Zahlungsmittel
- Klappversion - sofort nutzbar ohne Montage
- Flexibel einsetzbar durch integrierte Standfüße
- Mit Zubehör einsetzbar als Plakatständer oder Angebotstafel
- Außenmaß 640 x 885 mm, Fußlänge 505 mm, Plakatmaß 600 x 850 mm
- Unkomplizierte Reinigung mit herkömmlichen Reinigungsmitteln

### Spit protection for customers and employees!

- Hygienic separator made of beech wood, dark stained and acrylic glass
- Sound hole for clear communication
- Freestanding for table or counter
- Pass-through for products, documents or means of payment
- Folding version - immediately usable without assembly
- Flexible use thanks to integrated feet
- Outer Size: 640 x 885 mm, Foot length 505 mm, Poster Size: 600 x 850 mm
- Can be used with accessories as a poster stand or chalkboard
- Simple to clean. PET can be cleaned by regular cleaners and sanitizers



Art.-Nr.	Abmessungen (mm)	Ausführung
UWSCSD00A1X2000*	600 x 850	Acrylglas
UYPWSCS000X5002*	600 x 865 x 1	PET-Folienset
UYPWSCS000X5000*	600 x 865 x 3	Kreidetafel

\* Technische Änderungen vorbehalten!  
\* Technical changes reserved!



## Mobile Hygienewand WOOD | Mobile Hygienic Protection WOOD



- Thekenaufsteller aus Buchenholz, dunkel lasiert und Acrylglas
- Spuckschutz für Kunden und Mitarbeiter
- Schalllöcher für klare Kommunikation
- Freistehend für Tisch oder Theke
- Durchreiche für Produkte, Dokumente oder Zahlungsmittel
- Einfache Steckmontage
- Unkomplizierte Reinigung mit herkömmlichen Reinigungsmitteln

- Hygienic seperator made of beech wood, dark stained and acrylic glass
- Spit protection for customers and employees
- Speech opening for clear communication
- Freestanding for table or counter
- Pass-through for products, documents or means of payment
- Simple to clean. PET can be cleaned by regular cleaners and sanitizers



Art.-Nr.	Abmessungen (mm)
UWCPD07042X2000*	700 x 420

\* Technische Änderungen vorbehalten!  
\* Technical changes reserved!



## Hygieneschutz Deckenhänger | Suspended Hygienic Separator

- Hygiene Schutzsystem als Deckenhänger
- Ideal für den Einsatz über Verkaufstheken
- Set aus Abhängeschienen, transparenter Folie und Seilsystem
- Seilset 1,5 m lang
- Kostengünstige Lieferung des Sets als Rollenware
- Unkomplizierte Reinigung mit herkömmlichen Reinigungsmitteln

- *Hygiene protection system for ceiling suspension*
- *Ideal for use for sales counters*
- *Set consisting of hanging rails, transparent sheet and steel wire set*
- *Ceiling suspension set 1,5 m long*
- *Cost-effective delivery of the set as a coil*
- *Simple to clean. PET can be cleaned by regular cleaners and sanitizers*



Art.-Nr.	Abmessung (mm)
1604008*	1000 x 700

\* Technische Änderungen vorbehalten!  
\* Technical changes reserved!

## Bodenaufkleber | Floor Sticker

- Motive: "Bitte Abstand halten"
- Material: EasyFloor-Vinyl, mit Luftkanälen für einfache Montage, mit rutschfester Oberfläche
- Druck: 4/0 Digitaldruck
- Auf Format geschnitten, Ecken abgerundet
- B1 zertifiziert
- Haltbarkeit: circa 3 Monate

- *Motives: "Please keep distance"*
- *Material: EasyFloor-Vinyl, with air channels for easy assembly, with non-slip surface*
- *Print: 4/0 digital printing*
- *Cut to size, rounded corners*
- *With B1 certification*
- *Shelf life: around 3 months*



Auch im Querformat erhältlich  
Also available in Landscape format



Art.-Nr.	Abmessung (cm)	VPE (Stück)
3300005*	100 x 12,5	10
3300006*	40 x 40	10

\* Technische Änderungen vorbehalten!  
\* Technical changes reserved!



## Roll Banner Budget | Roll Banner Budget

- Rolldisplay für eine kostengünstige Präsentation
  - Das Banner wird oben geklemmt und unten geklebt
  - Stabiler Stand durch zwei Stellfüße
  - Nylon-Tragetasche mit Schulterriemen
- *Competitive Roll-Up display with 2 flexible legs*
  - *Top profile with clamp system and double-sided tape on the bottom*
  - *Stable stand thanks to two adjustable feet*
  - *Nylon-bag with shoulder strap*

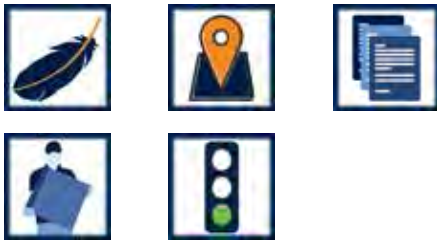

Art.-Nr.	Sichtmaß (mm)	Ausführung	Bannermaß (mm)
1259002	850 x 2000	ohne Druck	850 x 2000
1259003	1000 x 2000	ohne Druck	1000 x 2000
1259020	850 x 2000	mit Druck	850 x 2000
1259019	1000 x 2000	mit Druck	1000 x 2000



## Quick Banner | Quick Banner

- Flexibel nutzbares Bannerdisplay aus Aluminium
  - Ideal für den häufigen Wechsel der Grafiken
  - Leichter Auf- und Abbau ohne Werkzeug
  - Spezielle Banner-Klemmleisten für einen einfachen Wechsel der Banner
  - Nylon-Trageköcher auf Anfrage
- *Flexible aluminium banner-display*
  - *Ideal suited for frequent change of graphics*
  - *Toolless set-up and break-down*
  - *Easy change of banners by special banner-clamps*
  - *Nylon cartridge on request*



Nylon-Trageköcher

Art.-Nr.	Breite (mm) / Beschreibung
UQB0T00N72X1000	700 x 2000
UQB0T00N82X1000	800 x 2000
UQB0T00N92X1000	900 x 2000
UQB0T00N12X1000	1000 x 2000
UYUP066000X1000	Trageköcher für Banner bis 800 mm
UYUP067000X1000	Trageköcher für Banner bis 1000 mm



## Smart Roll Banner | *Smart Roll Banner*

- Einseitiges Roll-Up Display
- Banneraufsteller mit Kassette aus Aluminium
- Bannerhöhe kann zwischen 1000 und 2300 mm eingestellt werden
- Banner-Klemmleisten für einfachen Wechsel der Banner
- Nylon-Trageköcher mit Papphülle

- *Roll Banner display, single-sided*
- *Silver anodised aluminium case*
- *Height of banner adjustable from 1000 to 2300 mm*
- *Easy change of banners by special banner-clamps*
- *Comes with nylon cartridge*



Art.-Nr.	Breite (mm)
URBST00N00X5000	600
URBST00N00X5010	700
URBST00N82X2000	800
URBST00N00X5011	850
URBST00N92X2000	900
URBST00N12X2000	1000
URBST00N00X5014	1200
URBST00N00X5001	1500



## Outdoor Roll Banner | *Outdoor Roll Banner*

- Stabiles, wetterfestes Outdoor Roll Banner
- Ein- oder doppelseitig nutzbar
- Robuste, 3-teilige Spannstange mit Ausgleichsfeder
- Banner wird unten geklebt und oben geklemmt
- 4 Bodenanker zur Fixierung auf Freiflächen. Inkl. Nylon-Tragetasche

- *Stable, weatherproof outdoor roll banner!*
- *Single- or double-sided option*
- *3-parted pole with strong balance spring*
- *Top-profile with clamp system and double-sided tape on the bottom*
- *4 ground anchors for fixation in the ground. Padded nylon carry-on bag*



Art.-Nr.	Bannerformat (mm)
1271001	850 x 2000

# Bannersysteme | Banner Systems

## Falt-Prospektständer | Foldable Brochure Stands

### Poster Trap & Easy Swap | Poster Trap & Easy Swap



- Banner-Aufsteller aus Stahl, silberfarbig
  - Das System besteht aus zwei Elementen, die miteinander verschraubt werden
  - Starre Materialien von 5 bis zu 10 mm Stärke können fixiert werden
  - Maximale Höhe der Einleger ist 1500 mm
- *Banner-stand made of steel, silver colored*
  - *The system consists of 2 parts, that are screwed to each other*
  - *Panels from 5 to 10 mm thickness can be fixed*
  - *Maximum height of panel is 1500 mm*



- Preisgünstiger Banner-Aufsteller aus Aluminium
  - Panels von 5 bis zu 10 mm Stärke werden eingeklemmt
  - Fixierung durch Feststellschraube von unten
  - Maximale Höhe der Einleger ist 1500 mm
- *Low-cost aluminium banner stand*
  - *Panels from 5 to 10 mm thickness to be clamped*
  - *Lock screw is in the case*
  - *Maximum height of banner is 1500 mm*

Art.-Nr.	Modell	Breite (mm)
UMS0000300X1000	Poster Trap	300
UMS0000600X1000	Poster Trap	600
UMS0000800X1000	Poster Trap	800
UMS0000900X1000	Poster Trap	900
UMS0001000X1000	Poster Trap	1000
UMS0100300X1000	Easy Swap	300
UMS0100600X1000	Easy Swap	600
UMS0100800X1000	Easy Swap	800
UMS0100900X1000	Easy Swap	900
UMS0101000X1000	Easy Swap	1000
UMS0101200X1000	Easy Swap	1200
UMS0101500X1000	Easy Swap	1500



### Falt-Prospektständer BLACK | Foldable Literature Rack BLACK



- Faltbarer Prospektständer in komplett schwarzer Optik
  - 4 Ablagen für DIN A4 Prospekte
  - Einfach zusammenklappbar
  - Nylon-Transporttasche
  - Kann mit Prospekten transportiert werden
- *Foldable literature rack in black design*
  - *4 shelves for DIN A4 leaflets*
  - *Easy to fold*
  - *Nylon transport bag*
  - *Can be carried with leaflets*



Art.-Nr.	Format
1362013	4 x DIN A4

## Falt-Prospektständer, Holz/Acryl/Metall | *Foldable Brochure Rack, Wood/Acrylic/Metal*

- Falt-Prospektständer Zick-Zack mit 6 Ablagen
- Zugang zu Prospekten von 2 Seiten
- Interessante Optik und sekundenschneller Aufbau
- Ablagen erhältlich in glasklarem Acryl, Buche-Holzoptik oder schwarz gelochtem Blech
- Transportkoffer aus Aluminium mit Styropor Innenverkleidung

- *Foldable Zick-Zack brochure stand with 6 shelves*
- *Access to brochures from 2 sides*
- *Nice design and easy set-up*
- *Shelves available in crystal clear acrylic, beech wood finish or black perforated sheet metal*
- *Transport case made of aluminium with interior reinforcement*

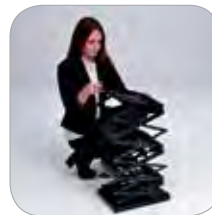
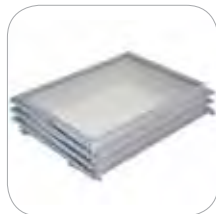

Art.-Nr.	Format (mm)	Farbe	Ablage
1362008	6 x DIN A4	silber eloxiert	Holz, gelocht
1362003	6 x DIN A4	silber eloxiert	Acryl, glasklar
1362004	6 x DIN A3	silber eloxiert	Acryl, glasklar
1362006	6 x DIN A4	schwarz eloxiert	Acryl, glasklar
1362007	6 x DIN A3	schwarz eloxiert	Acryl, glasklar
UFZHD10614X5000	6 x DIN A4	RAL 9005 schwarz	Metall gelocht

## Falt-Prospektständer Neu | *Foldable Brochure Rack New*

- Faltbarer Prospektständer in moderner Optik
- 5 glasklare Ablagen für DIN A4 Prospekte
- Einfach zusammenklappbar
- Nylon-Transporttasche mit Innenverstärkung
- Kann mit Prospekten transportiert werden

- *Foldable literature rack in modern design*
- *5 shelves for DIN A4 leaflets Shelves*
- *Easy to fold*
- *Nylon transport bag with interior reinforcement*
- *Can be carried with leaflets*



Art.-Nr.	Format (DIN)
UZZEPS0100X1000	5 x DIN A4

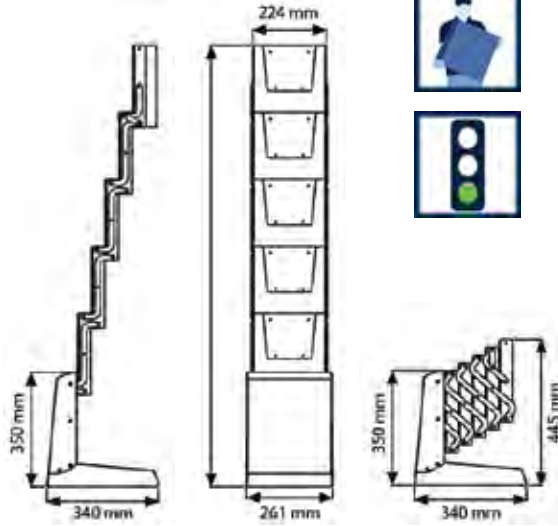

## Falt-Prospektständer TechArt | *Foldable Brochure Rack TechArt*

- Stabiler Falt-Prospektständer in modernem Lochblech-Design
- Schwarz pulverbeschichtet
- 4 Ablagen für DIN A4 Prospekte
- Einfach zusammenklappbar
- Nylon-Transporttasche mit Innenverstärkung

- *Foldable brochure stand in modern perforated sheet design*
- *Black powder coated*
- *4 shelves for DIN A4 brochures*
- *Easy set-up*
- *Nylon carry-on bag with internal reinforcement*



Art.-Nr.	Format
UFZHS10414X5000	4 x DIN A4





## Boden-Prospektständer Rapid | Floor Brochure Rack Rapid

- Mobiler Prospektständer
- Alu-Rahmengestell
- Erhältlich mit zwei oder drei Ablagen
- Ablagen aus satiniertem Acrylglas
- Neutrales Top-Schild für ein permanentes Branding

- *Mobile brochure stand*
- *Aluminium frame stand*
- *Available with 2 or 3 shelves*
- *Shelves made of frosted acrylic glass*
- *Neutral top-sign for a permanent branding*



Art.-Nr.	Format (DIN)	Abmessungen (BxHxT / mm)
URDB0002A4X1000	2 x A4	265 x 1000 x 350
URDB0003A4X1000	3 x A4	265 x 1290 x 350

## Boden-Prospektständer Cocktail, breit/schmal | Floor Brochure Rack Cocktail wide/narrow

- Modularer Prospektständer
- Wenig Platzbedarf aber viel Raum für Prospekte
- Gestell aus silberfarbigem Stahl – erhältlich in 2 Breiten
- Prospektboxen können variabel an den Traversen befestigt werden
- Gesamthöhe 1620 mm

- *Modular brochure stand*
- *Little footprint but plenty of space for brochures*
- *Silver steel stand - available in 2 widths*
- *Brochure boxes can be variably attached to the cross-bars*
- *Total height 1620 mm*

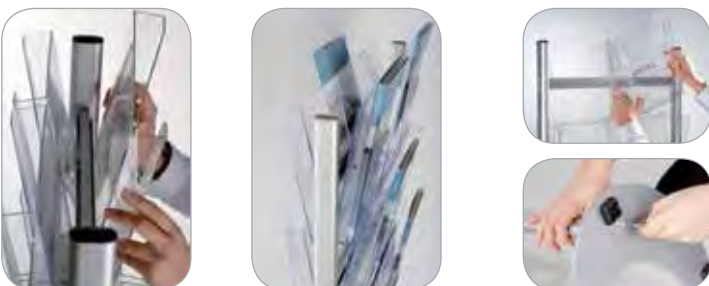

Art.-Nr.	Ausführung	Gestell	Format
1310010	doppelseitig	schmal	16 x DIN A4
1310011	doppelseitig	breit	24 x DIN A4
1310012	einseitig	schmal	8 x DIN A4
1310013	einseitig	breit	12 x DIN A4

## Boden-Prospektständer Multiside, drehbar/mit Laufrollen |

Brochure Stand Multiside rotatable/with castors

- 4-seitiger, drehbarer Prospektständer mit wenig Platzbedarf - Gestell aus Stahl – erhältlich in 2 Farben
- 2 oder 3-seitiger Prospektständer mit wenig Platzbedarf - Gestell aus Stahl mit Laufrollen
- Viel Raum für Prospekte
- Prospektboxen können variabel an den Traversen befestigt werden
- Gesamthöhe 1600 mm

- 4-sided, rotatable brochure stand - Steel stand - available in 2 colors
- 2 or 3-sided, rotatable brochure stand - Steel rack with wheels
- Little footprint but plenty of space for brochures
- Brochure boxes can be variably attached to the cross-bars
- Total height 1600 mm



Art.-Nr.	Ausführung	Farbe	Format
1310008	4-seitig, ohne Laufrollen	silber	20 x DIN A4
1310009	4-seitig, ohne Laufrollen	schwarz	20 x DIN A4
1310004	2-seitig, mit Laufrollen	silber	10 x DIN A4
1310005	2-seitig, mit Laufrollen	schwarz	10 x DIN A4
1310006	3-seitig, mit Laufrollen	silber	15 x DIN A4
1310007	3-seitig, mit Laufrollen	schwarz	15 x DIN A4

## Boden-Prospektständer Multiside, 2-, 3-, 4-seitig | Brochure Stand Multiside, 2-, 3-, 4-sided

- 2, 3 oder 4-seitiger Prospektständer mit wenig Platzbedarf
- Viel Raum für Prospekte
- Gestell aus Stahl
- Prospektboxen können variabel an den Traversen befestigt werden
- Gesamthöhe 1500 mm

- 2, 3 or 4-sided brochure stand
- Little footprint but plenty of space for brochures
- Steel rack
- Brochure boxes can be variably attached to the cross-bars
- Total height 1500 mm

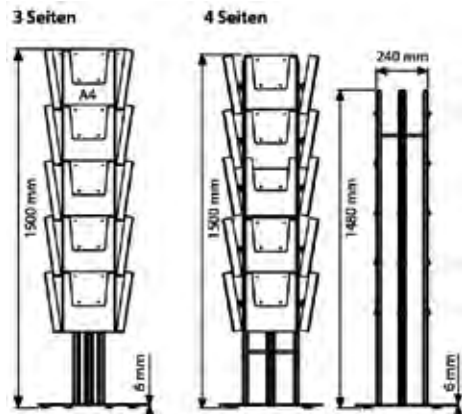

Art.-Nr.	Ausführung	Farbe	Format
1310001	4-seitig	silber	20 x DIN A4
1310002	3-seitig	silber	15 x DIN A4
1310003	2-seitig	silber	10 x DIN A4

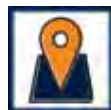

2-seitig



3-seitig



4-seitig

## Boden-Prospektständer TWIST | Brochure Stand TWIST

- Elegante Optik!
  - Stabiles Leitergestell in RAL 9006
  - Flexibel doppelseitig nutzbar dank Fußplatte mit Drehfunktion
  - Prospektboxen aus glasklarem Acryl werden durch Metallhalterungen in Schrägposition gehalten
  - Permanentes Branding optional
  - Gesamthöhe 1711 mm
- *Elegant look!*
  - *Sturdy ladder frame in RAL 9006*
  - *Flexible double-sided use thanks to rotatable base plate*
  - *Clear acrylic brochure boxes are held in an inclination by strong metal supports*
  - *Permanent branding optional*
  - *Total height 1711 mm*

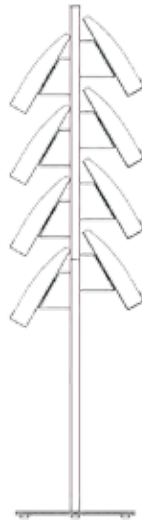

Art.-Nr.	Anwendung	Farbe	Format	Abmessung (mm)
UHDL12G030X5000	Doppelseitig	silber	8 x DIN A4	310 x 1711 x 400

## Dekorativer Boden-Prospektständer / Dekorativer Boden-Prospektständer Plus

*Decorative Brochure Stand / Decorative Brochure Stand Plus*

- Prospektständer mit silberfarbiger Bodenplatte und zentralem Ovalprofil
- Glasklare DIN A4 Prospektablage für Hoch- oder Querformat aus schlagfestem Polycarbonat
- Version "Plus" mit Acryl-Postertasche

- *Brochure stand with silver coloured base and central oval upright*
- *Clear acrylic brochure holder for DIN A4 portrait or landscape made of high impact polycarbonate*
- *Plus Version comes a long with easy to change header on top*

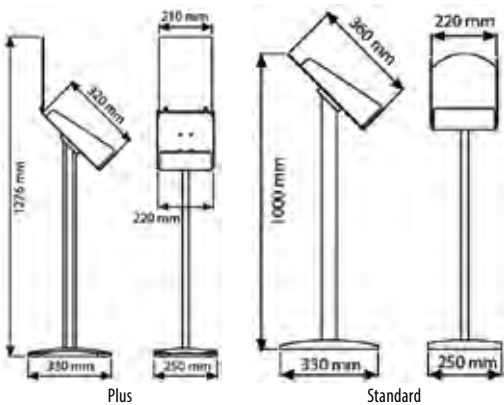

Art.-Nr.	Variante	Format (DIN)
UDBS10Y0A4X1000	Standard	A4 Querformat
UDBS10D0A4X1000	Standard	A4 Hochformat
UDBS20Y0A4X1000	Plus	A4 Querformat
UDBS20D0A4X1000	Plus	A4 Hochformat

## Boden-Prospektständer Outdoor PLUS | Brochure Stand Outdoor PLUS

- Praktischer Prospektständer für Innen- und Außen!
- Gestell und Prospektbox aus silberfarbigem Metall im Lochblech-Design
- Glasklare Info- oder Poster-Tasche für DIN A4 Hochformat mit seitlichem Einschub
- Mobil durch integrierte Laufrollen

- *Practical brochure stand for indoor and outdoor application!*
- *Stand and brochure box made of silver-colored metal in perforated design*
- *Crystal-clear info or poster pocket for A4 portrait format for lateral insertion*
- *Mobile thanks to integrated wheels*



Art.-Nr.	Ausführung	Format
PRJ0101169	silber	DIN A4



## Boden-Prospektständer Pillar | Pillar Brochure Stand

- Prospektständer mit zentralem Aluminium-Profil und Mehrfach-Prospektboxen
- Erhältlich für 3 x DIN A4 Prospekte oder 6 x DIN Lang Prospekte

- *Brochure stand with central upright profile and multiple brochure boxes*
- *Available for 3 x DIN A4 brochures or 6 x 1/3 DIN A4 brochures*

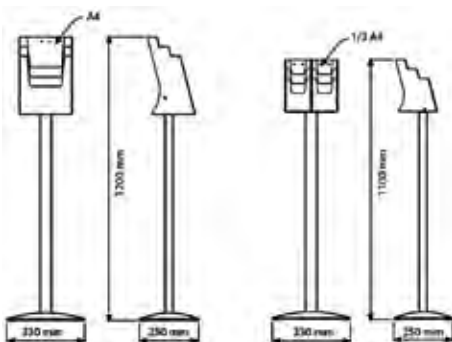

Art.-Nr.	Format (DIN)
UPBS3000A4X7700	3 x DIN A4
UPBS300A43X7700	6x DIN Lang



## Boden-Prospektständer Office | Brochure Stand Office

- Elegante Optik!
- Silber eloxierte Alu-Profile und Mittelplatte
- Doppelseitig nutzbar
- Prospektboxen werden einfach in Langlöcher eingehängt
- Permanentes Branding optional
- Gesamthöhe 1750 mm

- *Stylish Design!*
- *Silver anodised profile and panel*
- *Double-sided*
- *Brochure holders are fixed easily*
- *Total height 1750 mm*

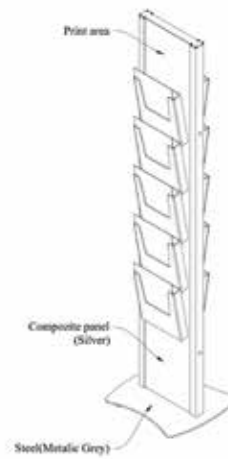
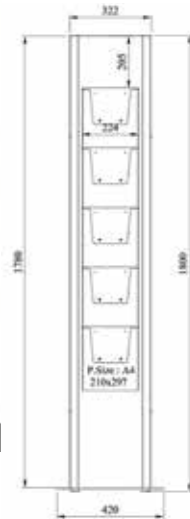

Art.-Nr.	Ausführung	Format
PRJ0101172	silber	10 x DIN A4

## Boden-Prospektständer Zick-Zack | Brochure Stand Zick-Zack

- Eleganter Prospektständer mit sechs Ablagen aus glasklarem Acryl und zentralem Ovalprofil, silber eloxiert
- Von allen Seiten zugänglich
- Einbeinig optional mit Top-Schild
- Zweibeinig inklusive Top-Rahmen für individuelle Headline
- Jetzt auch aus dunkel lasiertem Buchenholz (produziert aus zertifiziertem Holz) erhältlich!

- *Elegant leaflet rack with 6 clear shelves made of acrylic and central oval pole, silver anodised*
- *Allows access from all sides*
- *Standard one-leg version optional with header*
- *Double leg version inclusive header frame for individual headline*
- *Now also available in beech wood (made of certified wood)!*



Art.-Nr.	Format (DIN)	Modell
UZZTLT0001X1000	6 x A4	1-Beinig Standard
UZZTLT0002X1000	6 x A4	1-Beinig Standard mit Top-Schild
UZZCLT0002X1000	6 x A4	2-Beinig mit Top-Schild
UZZWD005A4X2000	6 x A4	Holz, dunkel

## Boden-Prospektständer Zebrano | *Brochure Stand Zebrano*

- Formschöner Boden-Prospektaufsteller aus dunkel lasiertem MDF- Buchenholz
- Edle Kombination aus Holz und Acrylglas
- 6 DIN A4 Prospektablagen
- *Elegant floor brochure display made of high-quality, dark-colored medium density fibreboard*
- *Stylish combination of wood and acrylic glass*
- *6 DIN A4 brochure trays*



Art.-Nr.	Format (DIN)	Fußplatte
UWPSDB03A4X2000	6 x DIN A4	schwarz
UWPSDD03A4X2000	6 x DIN A4	Holzoptik

## Boden-Prospektständer Brand | Brochure Stand Brand

- Formschöner Boden-Prospektaufsteller aus hochwertigem Buchenholz, dunkel lasiert, produziert aus zertifiziertem Holz
  - Die leicht nach hinten geneigte Prospektpräsentation zieht alle Blicke auf sich
  - Die 3 DIN A4 Prospektablagen haben eine Fülltiefe von 120 mm
  - Optional mit permanentem Branding
  - Auch erhältlich in gerader Version als Merchandiser
- *Elegant floor brochure display made of high-quality, dark lacquered, made of certified beech wood*
  - *The slightly sloping brochure presentation draws everyone's attention*
  - *3 DIN A4 brochure trays have a filling depth of 120 mm*
  - *Optionally with permanent branding*
  - *Available also in straight upright version as merchandiser*



Art.-Nr.	Format (DIN)
PRJ1006034	3 x DIN A4



## Boden-Prospektständer WoodMagazine | Brochure Stand Wood Magazine

- Freistehender, doppelseitiger Prospektständer aus Holz kombiniert mit Acrylglas
  - Hochwertiges Buchenholz, dunkel lasiert, produziert aus zertifiziertem Holz
  - Glasklare Prospektboxen
  - Auch einseitig als Wandversion erhältlich
- *Freestanding, double sided wooden brochure stand combined with acrylic glass*
  - *High quality beech wood, dark lacquered, made of certified wood*
  - *Crystal brochure boxes*
  - *Also available as a single sided wall version*



Wandversion 15 x DIN A4  
Wall Version 15 x DIN A4



Freistehend 10 x DIN A4  
Freestanding 10 x DIN A4



Freistehend 20 x DIN A4  
Freestanding 20 x DIN A4



Art.-Nr.	Ausführung	Format (DIN)
UWMRFD15A4X2000	Freistehend	10 x A4
UWMRFD25A4X2000	Freistehend	20 x A4
UWMRFD35A4X2000	Freistehend	30 x A4
UWMRFD45A4X2000	Freistehend	40 x A4
UWMRWD15A4X2000	Wand	5 x A4
UWMRWD25A4X2000	Wand	10 x A4
UWMRWD35A4X2000	Wand	15 x A4
UWMRWD45A4X2000	Wand	20 x A4



## Variation 70 Prospektbox-Ständer | Variation 70 Brochure Stand

- Einseitiger oder doppelseitiger Prospektständer für 8 x DIN A4 Prospekte
- Formschönes, ovales Zentralprofil
- Einseitige Ausführung mit seitlichen, in der Höhe verstellbaren Prospektboxen
- Doppelseitige Ausführung mit seitlichen, schräg montierten Prospektboxen
- Neutrales Topschild für permanentes Branding

- *Single or double face brochure stand for 8 x DIN A4 size*
- *Eye-catching central pole with lateral*
- *Single Version with height adjustable brochure boxes*
- *Double Version with aslope fixed brochure boxes*
- *Neutral header for permanent branding*



Top-Schild  
UFSL120100X1000

für Prospektständer mit Zentralprofil



Prospekt-Dispenser  
UFSL120000X1000

DIN A4 Wand-Prospektdispenser



Art.-Nr.	Format	Beschreibung
1300005	8 x DIN A4 hoch	Einseitig
1300006	8 x DIN A4 hoch	Doppelseitig



Einseitige Version  
Single face Version



Doepelseitige Version  
Double face Version

## Variation 70 Plakat-Prospektständer | Variation 70 Poster Stand

- Kombination von Plakat- und Prospektpräsentation
- Ein- oder doppelseitig lieferbar
- Stabile Bodenplatte mit Bodengleitern
- Ovale, silberfarbenes eloxiertes Zentralrohr
- 25 mm Klapprahmen im DIN A1 Format
- Prospektablage aus Acryl oder Metall (für 2 DIN A4 Prospekte im Hochformat)

- *Combination of poster- and brochure display*
- *Available single- or double sided*
- *Stable base plate with floor gliders*
- *Oval, silver-colored anodized central tube*
- *25 mm snapframe, Format DIN A1*
- *Brochure shelf made of acrylic glass or metal (for 2 DIN A4 leaflets)*

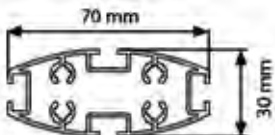

Art.-Nr.	Plakatformat (mm)	Profil	Prospektablage
1300007	594 x 841	25 mm, Gehrung	Acryl   2 x DIN A4
1300008	594 x 841	25 mm, Gehrung	Stahl   2 x DIN A4
1300019	594 x 841	25 mm, Gehrung	Stahl   3 x DIN A4

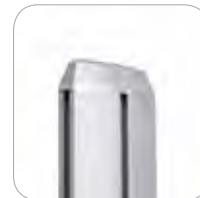

Prospekt-Ablage UFSL0023A4X5000  
3 x DIN A4 Metall Prospektablage in Lochblech-Optik



Prospekt-Ablage UFSL003000X1000  
2 x DIN A4 Acryl-Prospektablage für Prospektständer mit Zentralprofil



Prospekt-Ablage UFSL002000X1000  
2 x DIN A4 Metall-Prospektablage für Prospektständer mit Zentralprofil





## Konvex-Plakatständer auf Zentralprofilgestell | Free Standing Convex Box

- Auffälliger Plakatständer mit doppelseitigem Konvex-Rahmen
- Stabile Bodenplatte mit Bodengleitern
- Rundes Zentralrohr mit Systemnuten
- Optional beleuchtet oder mit Prospektablage aus Acryl oder Metall

- *Poster stand with double sided curved frame*
- *Stable base plate with floor gliders*
- *Round central upright with inbuilt grooves*
- *Optional brochure shelf made of acrylic glass or metal*

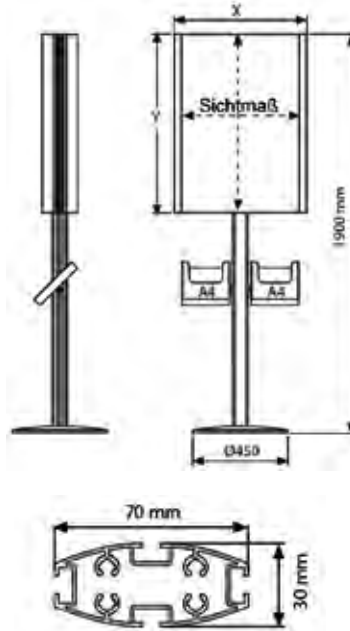

Art.-Nr.	Plakatmaß (mm)
UTTM014100X1000	420 x 594
UTTM014000X1000	594 x 841
UTTM014200X1000	500 x 700

## Bannerständer Variation 70 | Variation 70 Banner Stand

- Kombination aus Banner- und Prospektständer
- Stabile Bodenplatte mit Bodengleitern
- Ovale Zentralrohr mit 4 Systemnuten
- 600 mm Banner-Abhängeschiene
- 4 seitliche Prospektboxen für DIN A4 Prospekte

- *Banner Display with brochure presentation*
- *Stable base plate with floor gliders*
- *Elliptic central upright with 4 inbuilt grooves*
- *600 mm Banner suspension profile*
- *4 lateral brochure boxes for DIN A4 leaflets*

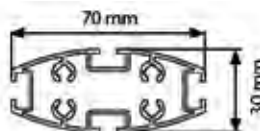

Art.-Nr.	Bannerformat (mm)	Prospektablage
1300009	600	Acryl   4 x DIN A4

## Variation 70 Prospektständer | Variation 70 Brochure Stand

- Ein- oder doppelseitiger Prospektständer für je 2 x DIN A4 Prospekte nebeneinander
  - Ovale Zentralprofil mit Acrylglas- oder Stahlblech-Prospektablagen
  - Neutrales Topschild für permanentes Branding
- Single- or double sided brochure stand for 2 x DIN A4 portrait format
  - Elliptic central upright with acrylic or steel shelves
  - Neutral header for permanent branding



Art-Nr.	Ausführung	Ablage	Format
1170018	einseitig	Acryl	8 x DIN A4
1170019	doppelseitig	Acryl	16 x DIN A4
1170020	einseitig	Stahlblech	8 x DIN A4
1170021	doppelseitig	Stahlblech	16 x DIN A4

## Variation Modulsystem | Variation Modular Stands

Art-Nr.	Beschreibung	Abmessungen   Plakatmaß (mm)
UFSL001200X2000	Ovales Zentral-Profil mit Bodenplatte	1920
UFSL0000A4X2000	Klapprahmen 25 mm, Gehrung	DIN A4
UFSL0000A3X2000	Klapprahmen 25 mm, Gehrung	DIN A3
UFSL0000A2X2000	Klapprahmen 25 mm, Gehrung	DIN A2
UFSL0000A1X2000	Klapprahmen 25 mm, Gehrung	DIN A1
UFSL0000B2X2000	Klapprahmen 25 mm, Gehrung	500 x 700
UFSL0000B1X2000	Klapprahmen 25 mm, Gehrung	700 x 1000
UFSL003000X1000	Acryl-Prospektablage	2 x DIN A4
UFSL002000X1000	Stahl-Prospektablage	2 x DIN A4
UFSL110000X1000	Banner Abhänge Set	400
UFSL110100X1000	Banner Abhänge Set	500
UFSL110200X1000	Banner Abhänge Set	600
UFSL110300X1000	Banner Abhänge Set	700
UFSL140000X1000	Prospektablage auf Alu-Profil	DIN A4
UFSL140100X1000	Prospektablage auf Alu-Profil	DIN A5
UFSL140200X1000	Prospektablage auf Alu-Profil	DIN Lang
UFSL120200X1000	Top-Schild	450 x 160
UFSL120000X1000	Prospektbox	DIN A4
UFSL130300X1000	Einschubrahmen	DIN A4
UFSL130200X1000	Einschubrahmen	DIN A3
UFSL130100X1000	Einschubrahmen	DIN A2



## NEU! Kombinationsständer Vario | Vario Modular Stand

- Innovativer Informationsträger oder Wegweiser
  - Wahlweise als Plakatständer, LED Leuchtdisplay mit Magnetrahmen oder Prospektständer
  - Ideal geeignet auch für permanentes Branding
  - Sehr standfest
- 
- *Stylish poster or literature stand*
  - *Optionally with snapframe or magnetic LED frame*
  - *Ideal also for permanent branding*
  - *Very stable*



Art.-Nr.	Produkt	Ausführung	Format (mm)
PRJ0101194	Plakatständer	einseitig	420 x 594
PRJ0101193	Plakatständer	einseitig	594 x 841
PRJ0101197	Leuchtdisplay	einseitig	420 x 594
PRJ0101196	Leuchtdisplay	einseitig	594 x 841
PRJ0101198	Prospektständer	einseitig 4 x DIN A4	4 x 210 x 297
PRJ0101199	Prospektständer	doppelseitig 8 x DIN A4	4 x 210 x 297

## Messesystem X-Truss 10 | Modular display system X-Truss 10

- Das patentierte Original
  - Modulares Displaysystem für Messe, Shop, Schaufenster, Events und Showroom
  - Leichter Aufbau ohne Werkzeug und passend für alle Medien
  - Stabile, sehr belastbare Konstruktion mit hoher Tragfähigkeit
  - Kompakt 10 x 10 cm in schwarz erhältlich
- *The patented original*
  - *Modular display system for exhibition, shop, shop-window, events and showroom*
  - *Easy and toolless set-up and suitable for all media*
  - *Sturdy, heavy-duty construction with very high load carrying capacity*
  - *Compact 10 x 10 cm available in black*



X-Truss Single Banner



X-Truss Wall Banner



X-Truss U-Shape 3 x 3



X-Truss Tower



X-Truss Corner Banner



X-Truss Triple Banner



X-Truss L-Shape 3 x 3

Art-Nr.	Model	Bannermaß (mm) B x H	Anzahl Banner	Farbe
1940001	Single Banner	1200 x 2100	1	schwarz
1940002	Corner Banner	1200 x 2100	3	schwarz
1940003	Triple Banner	1200 x 2100	2	schwarz
1940004	Wall Banner	2700 x 2100	1	schwarz
1940005	Tower	1200 x 4800	4	schwarz
1940006	L-Shape 3000 mm	2700 x 2100	2	schwarz
1940007	U-Shape 3000 mm	2700 x 2100	2	schwarz

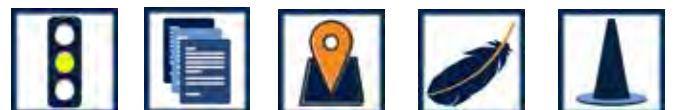

## Textil-Messesytem TUBE | Exhibition System TUBE

- Textiles Messesytem in vielen Breiten und Formen
- Kombination aus Rohrgestellen und Textildruck
- Keine sichtbaren Systemteile auer den T-Fuen
- Nylon Transporttasche
- Theke und LED Strahler optional
- Mit Reissverschluss konfektionierte Grafik wird einfach ber das System gezogen

- *Textile exhibition system in many widths and shapes*
- *Combination of tube system and textile printing*
- *No visible parts of the system except the T-feet*
- *Nylon carry-on bag*
- *Counter and LED spotlight optional*
- *Zippered graphics are simply dragged across the system*



Art.-Nr.	Format (mm)	Ausfhrung	Druck	Rohr (mm)
1423001	2400 x 2280	gerade	ohne	34
1423002	3000 x 2280	gerade	ohne	34
1423003	4000 x 2280	gerade	ohne	34
1423004	2400 x 2280	gerade	mit	34
1423005	3000 x 2280	gerade	mit	34
1423006	4000 x 2280	gerade	mit	34
1423007	2400 x 2280	konkav	ohne	34
1423008	3000 x 2280	konkav	ohne	34
1423009	2400 x 2280	konkav	mit	34
1423010	3000 x 2280	konkav	mit	34

## Jumbo Banner | Jumbo Banner

- Flexibler Banner-Stnder
- In der Breite einstellbar von 147 bis 315 cm und in der Hhe von 107 bis 247 cm
- Leichte, silberfarbige Aluminium-Konstruktion mit teleskopierbaren Seitenteilen und Quertraversen
- Ideal geeignet fr Stoff-Banner
- Einfacher, sekundenschneller Aufbau
- Nylon-Tragetasche

- *Banner stand adjustable in width from 147–315 cm and height from 107–247 cm*
- *Lightweight, silver colored aluminium construction with telescoping uprights and cross-bars*
- *Ideally suited for fabric banners*
- *Easy set-up of the system in only a few Minutes*
- *Comes with nylon carry-on bag*

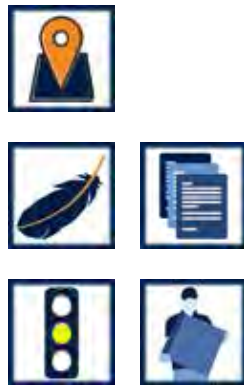

Art.-Nr.	Bannerma (mm)
1422001	3150 x 2470

## Promotion-Theke/Petit | Promostand/Petit

- Einfache und preiswerte Kunststoff-Theke
- Faltbarer Korpus mit tiefgezogener Boden- und Deckelplatte sowie Zwischenboden
- Inkl. Logo-Aufsatz und Tragetasche
- Grafikproduktion auf Anfrage

- *Simple and low-cost counter produced in white plastic*
- *Foldable and easy to transport and mount*
- *Comes with top, shelf and header, transport bag optionally*
- *Graphic production on request*



UYUP072200X1000  
Nylon-Tragetasche für  
Promotion-Theke



Art.-Nr.	Beschreibung	Ausführung	Maße (mm)	Breite Thekenplatte (mm)
UTS00N5000X1000	ohne Transporttasche	Standard	510 x 2200	900
UTS00N5100X1000	mit Transporttasche	Standard	510 x 2200	900
UTS00N3000X1000	ohne Transporttasche	Petit	390 x 2150	700
UTS00N3100X1000	mit Transporttasche	Petit	390 x 2150	700

## Klapprahmen-Falttheke | Snapframe Counter

- Praktische falttheke
- Bewährte Klapprahmen für den Einsatz von einfachen Papierplakaten
- Robuster Zwischenboden für viel Stauraum
- Nylon Tragetasche als Zubehör

- *Practical folding counter*
- *Proven snap frame Technology for use of paper posters*
- *Intermediate shelf for plenty of storage space*
- *Nylon transport bag optional*



Art.-Nr.	Plakatmaß (mm)	Beschreibung
PRJ0101184	594 x 841 + 375 x 841	
UYUP077000X5002		Transporttasche

Falttheke Konvex / Falttheke Midsize Konvex | Convex Panset Counter / Midsize Convex Counter

- Falttheke aus Alu-Zahnkranzprofil und weißen PVC-Leichtschäumplatten
- Deckelplatte wahlweise weiß oder in Buchenholzdekor
- Zwischenboden aus weißem Kunststoff
- Nylon-Tragetasche optional
- Ausführung mit Bar-Aufsatz auf Anfrage

- Folding counter, combination of aluminium gearing profile and PVC foam sheets
- Top-plate either white or beech wood-look
- Shelf made of white PVC
- Nylon carry-on bag optional
- Version with bar-top on request



UYUP070200X1000  
Nylon-Tragetasche für  
Konvex /Midsize Konvex  
Falttheke



Art.-Nr.	Modell	Plattenmass (mm)
UPSM002000X1000	Konvex - Weiße Deckelplatte	878 x 980 / 878 x 430
UPSM008000X1000	Konvex - Buche Deckelplatte	878 x 980 / 878 x 430
UPSM052000X1000	Midsize - Weiße Deckelplatte	800 x 930 x 470
UYUP074000X1000	Tragetasche für Konvex Falttheke	
UYUP070200X1000	Tragetasche für Midsize Falttheke	
Art.-Nr.	Beschreibung	
3254031	Druck für Konvex Theke	
3254002	Druck für Midsize Konvex-Theke auf 3 mm Hartschaum	787 x 878 x 335

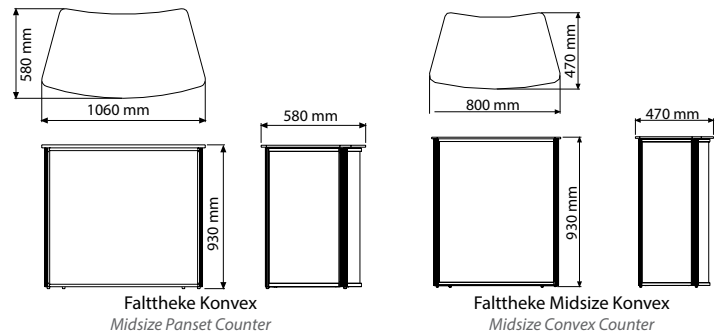

Quattro Falttheke + Sechseck Falttheke | Square Counter + Hexagonal Panset Counter

- Kompakte Viereck-Theke
- Tischplatte in Holzoptik
- Weißer Zwischenboden
- Einfacher Aufbau ohne Werkzeug
- Inkl. Nylon-Transporttasche mit Tragegriffen

- Elegant square counter
- Table top in wood look
- White intermediate shelf
- Easy Set up without tools
- Incl. Nylon carrying bag with carrying handles



Nylon-Tragetasche für  
Quattro Falttheke



- Falt-Theke mit viel Stauraum für Kataloge
- Alu-Zahnkranzprofil mit weißen Leichtschäum-Panelen
- Deckelplatte wahlweise aus weißem Kunststoff oder in Buchenholzdekor
- Zwischenboden aus weißem Kunststoff
- Nylon-Tragetasche und Grafikproduktion auf Anfrage

- Folding counter with large space for catalogues and equipment
- Made of aluminium profiles and white PVC-foam
- Top-plate available in white PVC-foam or beech wood design
- Shelf made of white PVC-foam
- Nylon carry-on bag and graphic production on request



UYUP074100X1000  
Nylon-Tragetasche für  
Sechseck Falttheke



Art.-Nr.	Ausführung	Modell	Format (mm)
UPSM010000X5013	Quattro-Falttheke	Holz Deckelplatte	374 x 877 x 360 mm
Art.-Nr.	Ausführung	Modell	Plattenmaß BxH (mm)
UPSM001000X1000	Sechseck-Falttheke	Theke mit weißer Deckelplatte	659 x 878 / 311 x 878
UPSM007000X1000	Sechseck-Falttheke	Theke mit Buche-Deckelplatte	659 x 878 / 311 x 878
UYUP074100X1000	Sechseck-Falttheke	Tragetasche	
Art.-Nr.	Ausführung	Beschreibung	
3254018	Sechseck-Falttheke	Druck Sechsecktheke	
3254030	Quattro-Falttheke	Druck Quattro-Falttheke	

## MaxiFrameLED Theke GO | MaxiFrameLED Counter GO



- Stabile, vollwertige LED Theke
- Viel Stauraum für Prospekte
- Einfacher Aufbau ohne Werkzeug
- MaxiFrameLED 100 Leuchtrahmen mit Theken- Set aus Holz
- Trolley für einfachen Transport

- *Stable, hands-on LED counter*
- *Lots of storage space for brochures*
- *Easy set-up without tools*
- *MaxiFrameLED 100 textile frame with wooden counter set*
- *Trolley for easy transport*



Art.-Nr.	Ausführung	Schrankfarbe	Format (mm)
1188003	Theke mit Schrank	hell	1000 x 1000 mm
1188004	Theke mit Schrank	Holzoptik Buche	1000 x 1000 mm
Art.-Nr.	Beschreibung		
1188005	Trolley		

## LED Viereck-Falttheke | LED Square Panset Counter



- LED Falttheke mit viel Stauraum für Prospekte
- Einfacher Aufbau ohne Werkzeug
- Kombination aus Alu-Zahnkranzprofil und LED Technik
- Front beleuchtet – Seiten unbeleuchtet

- *LED folding counter with plenty of storage space for brochures*
- *Easy set up without tools*
- *Smart combination of aluminum profile and LED curtain*
- *Front illuminated - sides unlit*



Art.-Nr.	Grafikmaß (mm)
1410024	1 x 926 x 856   Durchlicht   2 x 427 x 856   Aufsicht



Falt-Prospektständer Stehpult | Foldable Counter Standing Desk

- Robuster Falt-Prospektständer in modernem Design!
  - Platz für 6 x DIN A4 Prospekte im Hochformat oder 3 x DIN A3 Prospekte im Querformat
  - Ideal als Rednerpult oder Messestheke
  - Tischplatte in schwarz oder Buche, dunkel lasiert
  - Tragetasche aus Nylon mit Styropor-Innenauskleidung
  - Optional auch erhältlich komplett in weiß
- Robust folding counter in a modern design!
  - Takes 6 x DIN A4 brochures in portrait format or 3 x DIN A3 brochures in landscape format
  - Table top allows use as speakers desk or exhibition counter
  - Table top in black or beech, dark lacquered
  - Nylon carrying case with inner reinforcement for protection
  - Optionally also available completely in white colour



Art.-Nr.	Farbe	Tischplatte	Format
UWFH1D1324X5000	Schwarz	Buche, dunkel	6 x DIN A4
UWFH1B1324X5000	Schwarz	Schwarz	6 x DIN A4
UWFH1B0314X5000	Schwarz	Schwarz	3 x DIN A4

## Stehpult AMBIENTE | High Desk AMBIENTE

- Design Stehpult
  - Edle Kombination aus Metall und ESG-Glas
  - Standfest durch Stahl-Bodenplatte mit Bodengleitern
  - Glas Ablage schräg montiert auf 2 Profilen
- 
- *Design Podium*
  - *Stylish combination of metal and tempered glass*
  - *Stable thanks to steel base plate with floor gliders*
  - *Glass shelf mounted angled on 2 profiles*

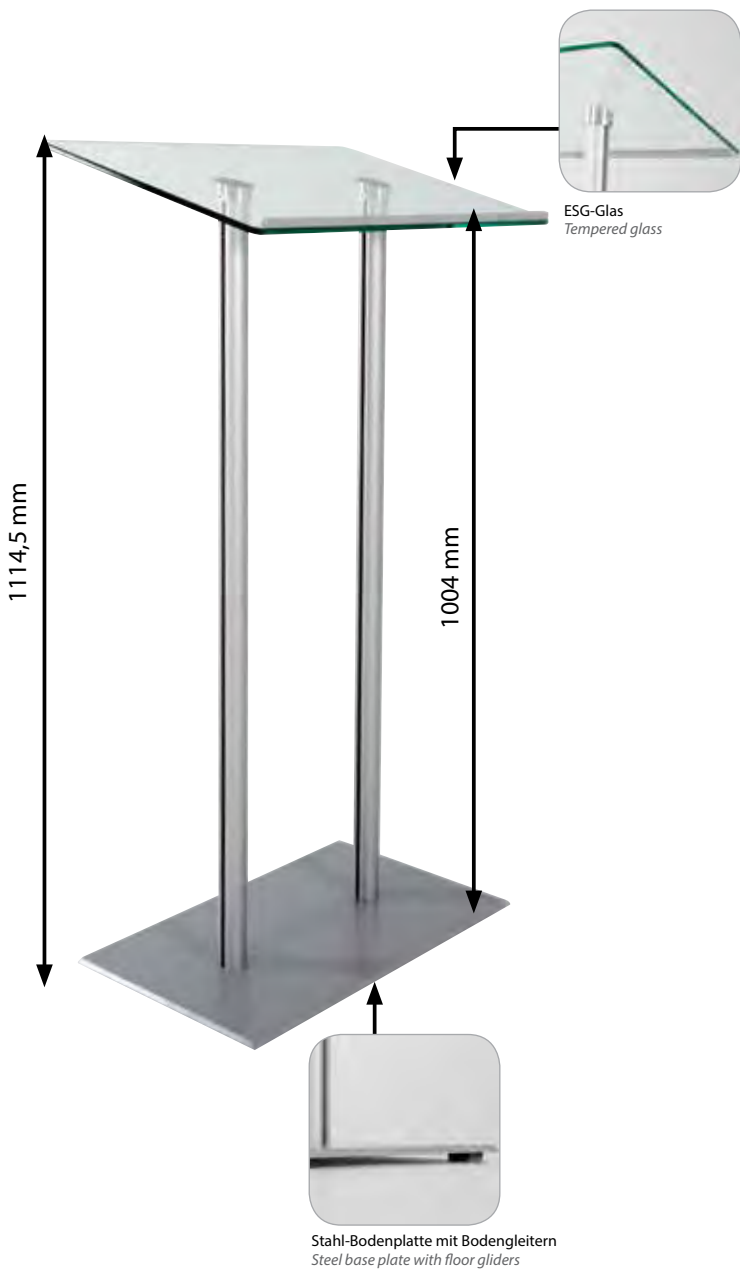

Art.-Nr.	Farbe	Glas Ablage (mm)	Gesamthöhe (mm)
UGPDN0200X2000	silber	600 x 400	1.114,50

## Mehrfach Prospektdispenser | Multiple Pocket Leaflet Dispensers

- Prospektdispenser aus glasklarem Polystyrol
- Für freistehende Aufstellung auf Tisch oder Theke
- Erhältlich in den Formaten 3 x DIN Lang, 4 x DIN Lang, 3 x DIN A5 und 3 x DIN A4
- Logo-Siebdruck auf Anfrage

- *Brochure holders made from clear polystyrene*
- *Freestanding on table or counter*
- *Available in 3 x 1/3 DIN A4, 4 x 1/3 DIN A4, 3 x DIN A5, 3 x DIN A4*
- *Branding of brochure holders on request*

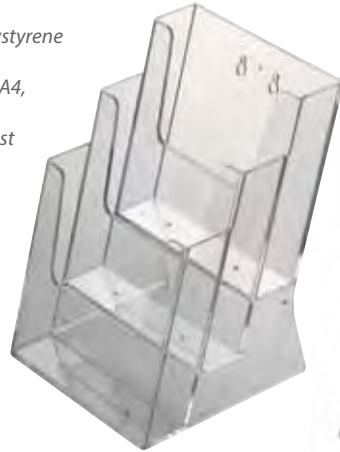

3 x DIN A4 Hochformat



3x DIN Lang Hochformat



3x DIN A5 Hochformat

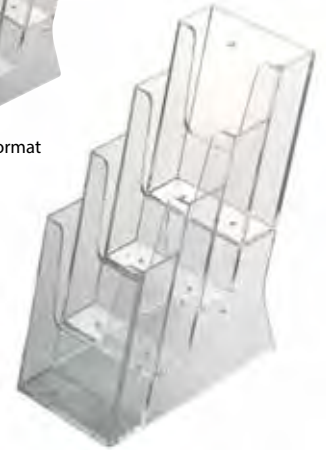

4x DIN Lang Hochformat

Art.-Nr.	Format (mm)	Beschreibung	VPE
UMSD003000X1000	210 x 297	3 x DIN A4 Hochformat	4
UMSD003050X1000	105 x 210	4 x DIN Lang Hochformat	18
UMSD004000X1000	148 x 210	3 x DIN A5 Hochformat	12
UMSD005000X1000	105 x 210	3 x DIN Lang Hochformat	20



## Wand-Prospektdispenser | Wall Mounted Leaflet Dispensers

- Prospektdispenser aus glasklarem Polystyrol für die Wandmontage
- Erhältlich in den Formaten DIN Lang, DIN A5 und DIN A4
- Logo-Siebdruck auf Anfrage
- Version mit Klappdeckel ist für Außeneinsatz geeignet

- *Clear polystyrene dispenser for wall mounting*
- *Available in 1/3 DIN A4, DIN A5 and DIN A4*
- *Logo printing on request*
- *Version with hinged cover is suitable for outdoor use*



Erhältlich in DIN A5 und DIN A4  
Available in DIN A5 and DIN A4



DIN Lang



Art.-Nr.	Anwendung	Format (DIN)
UMSD006000X1000	Inneneinsatz	DIN Lang
UMSD007000X1000	Inneneinsatz	A5
UMSD008100X2000	Inneneinsatz	A4
1603001	Außeneinsatz	DIN Lang
1603002	Außeneinsatz	A5
1603004	Außeneinsatz	A4



Outdoor Version mit klappbarem Deckel  
Outdoor Version with hinged cover

## Tisch-Prospektdispenser | Leaflet Dispensers

- Prospektdispenser aus glasklarem Polystyrol
- Für freistehende Aufstellung auf Tisch oder Theke
- Erhältlich in den Formaten DIN Lang, DIN A5 und DIN A4 sowie
- Mit Trennsteg auch für 2 x DIN Lang
- Logo-Siebdruck auf Anfrage

- *Brochure holders made from clear polystyrene*
- *Freestanding on table or counter*
- *Available in 1/3 DIN A4, DIN A5, DIN A4*
- *With T-separator also for 2 x 1/3 DIN A4 size*
- *Branding of brochure holders on request*



DIN Lang



DIN A4



UYUP449601X1001  
Trennsteg für DIN A4  
T-separator for DIN A4 size



Art.-Nr.	Format (DIN)	Druckbereich (mm)	Beschreibung	VPE
UMSD001005X1001	A4	40 x 90	Hochformat	20
UMSD001004X1001	A5	55 x 140	Hochformat	40
UMSD001003X1001	DIN Lang	70 x 200	Hochformat	50
UYUP449601X1000	A4		Trennsteg	20



## Holz Tischaufsteller VINTAGE | Wood Menu Holder VINTAGE



- Tischaufsteller aus Buchenholz, dunkel lasiert
- Integrierte Einschub Nut
- Kombinierbar mit Kreidetafel oder Acryl-Poster Tasche

- Menu holder made of beech wood, dark lacquered
- Can be used with chalkboard panel or acrylic pocket
- Inbuilt groove

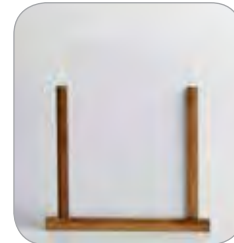

Art.-Nr.	Beschreibung	Format (DIN)
1707001	Tischaufsteller mit Kreidetafel	A5 hoch
1707002	Tischaufsteller mit Kreidetafel	A4 hoch
1707003	Tischaufsteller mit Acryltasche	A5 hoch
1707004	Tischaufsteller mit Acryltasche	A4 hoch
Art.-Nr.	Beschreibung	Farbe
UYAKLM1251X1000	Kreidestifte, 10 mm breit, 5 er Set	bunt
UYAKLM1250X1000	Kreidestifte, 10 mm breit, 3 er Set	weiß

## Holz Tischaufsteller ARCADE | Wood Menu Holder ARCADE



- Tischaufsteller aus massivem Buchenholz, dunkel lasiert
- Konvex gewölbte Form
- Acryl Poster-Tasche für Papier Einleger

- Menu holder made of solid beech wood, dark lacquered
- Outward curved shape
- Comes with acrylic pocket for paper inlays



Art.-Nr.	Beschreibung	Format (DIN)
UWDMOCD0A5X2000	Holz Aufsteller mit Acryltasche	A5 hoch
UWDMOCD0A4X2000	Holz Aufsteller mit Acryltasche	A4 hoch

## Holz Klemmfuß DOUBLE | Wood Menu Holder DOUBLE

- Holz Klemmfuß aus massivem, zertifiziertem Buchenholz, dunkel lasiert
  - 90 oder 75 Grad Nut nutzbar
  - Geeignet für Kreidetafel (beschreibbar und feucht oder nass abwischbar) oder Acryl Postertasche
  - Nut für 4 mm Einschub
- Wood base made of certified, solid beech wood, dark lacquered
  - 90 or 75 degree groove
  - Can be used with chalkboards (writable and moist or wet wipeable) or poster pocket
  - Groove for 4 mm insert



Art.-Nr.	Beschreibung	VPE	Format (mm)
UWCHOD0070X5000	Holz Klemmfuß mit 2 Nuten	10	70 mm
UWCHOD0105X5001	Holz Klemmfuß mit 2 Nuten	10	105 mm
UWCHOD0150X5001	Holz Klemmfuß mit 2 Nuten	10	150 mm
UWCHOD0210X5001	Holz Klemmfuß mit 2 Nuten	10	210 mm
1608009	Kreidetafel, 4 mm PVC	10	74 x 105
1608010	Kreidetafel, 4 mm PVC	10	105 x 148
1608011	Kreidetafel, 4 mm PVC	10	148 x 210
1608012	Kreidetafel, 4 mm PVC	10	210 x 297
UPCUAD00A6X2000	Acrylglastasche	10	105 x 148
UPCUAD00A5X2000	Acrylglastasche	10	148 x 210
UPCUAD00A4X2000	Acrylglastasche	10	210 x 297
Art.-Nr.	Beschreibung		Farbe
UYAKLM1251X1000	Kreidestifte, 10 mm breit, 5 er Set		bunt
UYAKLM1250X1000	Kreidestifte, 10 mm breit, 3 er Set		weiß

## Holz Klemmfuß Pyramid | Wood Menu Holder Pyramid

- Holz Klemmfuß aus zertifiziertem, massivem Buchenholz, dunkel lasiert
  - Geeignet für Kreidetafel (beschreibbar und feucht oder nass abwischbar) oder Acryl Postertasche
  - Nut für 4 mm Einschub
- Wood base made of solid, certified beech wood, dark lacquered
  - Can be used with chalkboards (writable and moist or wet wipeable) or poster pocket
  - Groove for 4 mm insert



Art.-Nr.	Beschreibung	VPE	Format (mm)
UWCHPD0070X5000	Holz Klemmfuß	10	70 mm
UWCHPD0105X5000	Holz Klemmfuß	10	105 mm
UWCHPD0150X5000	Holz Klemmfuß	10	150 mm
UWCHPD0210X5000	Holz Klemmfuß	10	210 mm
1608009	Kreidetafel, 4 mm PVC	10	74 x 105
1608010	Kreidetafel, 4 mm PVC	10	105 x 148
1608011	Kreidetafel, 4 mm PVC	10	148 x 210
1608012	Kreidetafel, 4 mm PVC	10	210 x 297
UPCUAD00A6X2000	Acrylglastasche	10	105 x 148
UPCUAD00A5X2000	Acrylglastasche	10	148 x 210
UPCUAD00A4X2000	Acrylglastasche	10	210 x 297
Art.-Nr.	Beschreibung		Farbe
UYAKLM1251X1000	Kreidestifte, 10 mm breit, 5 er Set		bunt
UYAKLM1250X1000	Kreidestifte, 10 mm breit, 3 er Set		weiß



## Holz Staffelei Desktop | Wood Easel Desktop

- Mini Staffelei für Tisch oder Theke
  - Ideal für die Preisauszeichnung
  - Kreidetafel fixiert (Beschreibbar und feucht abwischbar mit Microfasertuch)
  - Buchenholz hell lasiert
- *Mini easel for table or counter*
  - *Ideal for price tags*
  - *Chalkboard fixed (Writable and wet wipeable with Microfibre cloth)*
  - *Light glazed beech wood*



Fixierte Kreidetafel  
Chalkboard fixed



Staffelei  
Easel



Art.-Nr.	Format (mm)	Ausführung	Farbe
UWDECD00A4X2000	215 x 280	Fixierte Kreidetafel	schwarz
PRJ0101227	350 x 180	Nur Staffelei	Buche hell
Art.-Nr.	Beschreibung	Ausführung	Farbe
UYAKLM1250X1000	Kreidestifte, 3 er Set	10 mm	weiß

## Holz Klemmbrett Desk | Wood Clipboard Desk

- Freistehendes Klemmbrett, dunkel lasiert
  - Ideal für Tisch Dekorationen und Preisauszeichnungen
  - Doppelseitig nutzbar
  - Zusätzlich beschreibbar mit Kreidemarkern
- *Freestanding clipboard, dark glazed*
  - *Ideal for table decorations and price tags*
  - *Can be used double sided*
  - *Can also be used for chalk markers*



Art.-Nr.	Format (mm)	Farbe
UWCBCD00A4X2000	210 x 297	Dunkel
Art.-Nr.	Beschreibung	Farbe
UYAKLM1250X1000	Kreidestifte, 10 mm, 3 er Set	weiß

VINTAGE Kundenstopper Desktop | VINTAGE Desktop A-Board

- Dekorativer Tischaufsteller
- Beidseitig mit Kreidetafel (Beschreibbar und feucht oder nass abwischbar)
- Kordel im Vintage Look
- Dunkle Holzoptik

- *Decorative table stand*
- *With chalkboard on both sides (Writable and moist or wet wipeable)*
- *Natural cord for vintage look*
- *Dark lacquered wood finish*



Art.-Nr.	Beschreibung	Format (mm)
UWNLOD00A4X2000	A-Tischaufsteller, dunkel lasiert	210 x 300
Art.-Nr.	Beschreibung	Farbe
UYAKLM1250X1000	Kreidestifte, 10 mm, 3 er Set	weiß



Holz Trinkgeldbox | Wooden Tip Box

- Trinkgeldbox aus Vollholz
- Deckel abschliessbar und abnehmbar
- Gravur „TIP BOX“
- Perfekt für Gastronomie und Hotellerie

- *Solid wood tip box*
- *Lid lockable and removable*
- *"TIP BOX" engraving*
- *Perfect for gastronomy and the hotel industry*



Art.-Nr.	Beschreibung	Format (mm)
UTBXWD0010X2000	Trinkgeldbox, abschließbar	130 x 172 x 130

## T-Aufsteller Swing Wing | T-Stand Swing Wing

- Eleganter Menükartenhalter mit Aluminium-Klemmfuß der variabel Materialstärken zwischen 1 und 4 mm aufnehmen kann
- Neben Acryltaschen können auch andere Materialien wie PVC, PET oder PS als Info-Träger verwendet werden
- *Elegant menu card holder with silver anodised aluminium clamp base, that can take acrylic and other pockets*
- *Also it can hold different materials from up 1 mm to 4 mm thickness*



Art.-Nr.	Format hoch (mm)	Ausführung	VPE
USWMDNPOA7X1000	74 x 105	Alu-Klemmfuß mit Acryl-Tasche	15
USWMDNPA43X1000	105 x 210	Alu-Klemmfuß mit Acryl-Tasche	30
USWMDNPOA6X1000	105 x 148	Alu-Klemmfuß mit Acryl-Tasche	30
USWMDNPOA5X1000	148 x 210	Alu-Klemmfuß mit Acryl-Tasche	25
USWMDNPOA4X1000	210 x 297	Alu-Klemmfuß mit Acryl-Tasche	15
Art.-Nr.	Format quer (mm)	Ausführung	VPE
USWMYNPOA7X1000	74 x 105	Alu-Klemmfuß mit Acryl-Tasche	10
USWMYNPA43X1000	105 x 210	Alu-Klemmfuß mit Acryl-Tasche	15
USWMYNPOA6X1000	105 x 148	Alu-Klemmfuß mit Acryl-Tasche	25
USWMYNPOA5X1000	148 x 210	Alu-Klemmfuß mit Acryl-Tasche	15
USWMYNPOA4X1000	210 x 297	Alu-Klemmfuß mit Acryl-Tasche	10
Art.-Nr.	Format (mm)	Ausführung	VPE
USWMONP100X1000	100	Alu-Klemmfuß	12
USWMONP105X1000	105	Alu-Klemmfuß	12
USWMONP148X1000	148	Alu-Klemmfuß	6
USWMONP210X1000	210	Alu-Klemmfuß	28
USWMONP297X1000	297	Alu-Klemmfuß	20

## Acryl T-Aufsteller | Clear Brochure Holder T-Type Acrylic

- Glasklarer Acrylaufsteller in T-Form
- Hoch- oder Querformat
- Erhältlich in den Formaten DIN A6, DIN A5, DIN Lang, DIN A4
- *Clear acrylic T-stand*
- *Portrait and landscape*
- *Available for DIN A6, DIN A5, 1/3 DIN A4 and DIN A4*



DIN A5 Querformat



DIN A6 Querformat



DIN A6 Hochformat



DIN Lang Hochformat



DIN A4 Hochformat

Art.-Nr.	Format (DIN)	Beschreibung	VPE
UMSTD01000X1100	210 x 297	A4 Hochformat	40
UMSTY01000X1100	297 x 210	A4 Querformat	30
UMSTD02000X1100	148 x 210	A5 Hochformat	30
UMSTY02000X1100	210 x 148	A5 Querformat	30
UMSTD03000X1100	105 x 148	A6 Hochformat	40
UMSTY03000X1100	148 x 105	A6 Querformat	30
UMSTD04000X1100	105 x 210	DIN Lang Hochformat	40
UMSTY04000X1100	210 x 105	DIN Lang Querformat	50





## Kreidetafel L-Aufsteller | Calkboard L-Stand

- L-Aufsteller mit Schreibfläche aus 5 mm PVC
- Geeignet für Kreidemarker
- Leicht und stabil
- Kreidemarker optional
- *L-stand with calkboard surface made of 5 mm PVC*
- *Suitable for chalk markers*
- *Lightweight and stable*
- *Chalk markers optional*



Art.-Nr.	Beschreibung
1608001	105 x 148
1608002	148 x 210
1608003	210 x 297
Art.-Nr.	Beschreibung
UYAKLM1250X1000	Kreidestifte, 10 mm breit, 3 er Set, weiß

## NEU! Desktop Menüständer KONKAV |

ARC Desktop Menu Holder

- Stilvoller Menüständer im geschwungenen Design
- Elegante Präsentation von Speisekarten oder Informationen
- Pulverbeschichtetes Stahlblech
- Einfacher Wechsel der Einleger durch Magnetfolie
- *Stylish menu holder with curved design*
- *Elegant presentation of information*
- *Stable base made of powder-coated steel*
- *Easy change of graphic by magnetic poster cover*



Art.-Nr.	Plakatmaß(mm)	Ausführung	VPE
UMSAMPOGA4X2000	210 x 297	silber	2
UMSAMPOBA4X2000	210 x 297	schwarz	2

## Acryl L-Aufsteller | Clear Brochure Holder L-Type

- Glasklarer Acrylaufsteller in L-Form
- Hoch- oder Querformat
- Erhältlich in den Formaten DIN A6, DIN A5, DIN Lang, DIN A4
- *Clear acrylic L-stand*
- *Portrait and landscape*
- *Available for DIN A6, DIN A5, DIN A4 and 1/3 DIN A4*



DIN A6  
Querformat

DIN A5  
Querformat



DIN A6  
Hochformat

DIN A5  
Hochformat



DIN Lang  
Hochformat

DIN A4  
Hochformat

Art.-Nr.	Format (DIN)	Beschreibung	VPE
UMSLD01000X1100	210 x 297	A4 Hochformat	40
UMSLY01000X1100	297 x 210	A4 Querformat	30
UMSLD02000X1100	148 x 210	A5 Hochformat	40
UMSLY02000X1100	210 x 148	A5 Querformat	30
UMSLD03000X1100	105 x 148	A6 Hochformat	30
UMSLY03000X1100	148 x 105	A6 Querformat	30
UMSLD04000X1100	105 x 210	DIN Lang Hochformat	65
UMSLY04000X1100	210 x 105	DIN Lang Querformat	50

**NEU!** Mobile Arbeitsstation WOOD | *Mobile Workstation WOOD*



- Höhenverstellbare Arbeitsstation für ergonomisches Arbeiten
- Stehpult in modernem Leiter-Design
- Sekundenschneller, werkzeugloser Auf- und Abbau
- Hochwertige Einzelteile aus haltbarem Sperrholz, natur
- Nylon-Transporttasche optional
- Ablagen für Notebook und Tastatur

- *Height-adjustable workstation for ergonomic working*
- *Standing desk in a modern ladder design*
- *Tool-free set-up and knock-down in seconds*
- *High-quality individual parts made of durable plywood, natural*
- *Optional nylon transport bag*
- *Trays for notebook and keyboard*



Art.-Nr.	Ausführung	Abmessung (mm)
PRJ0101427	Sperrholz natur	800 x 750 x 400

## Visitenkartenbox | Business Card Holder

- Visitenkartenständer aus glasklarem Polystyrol Polystyrol
- Business card holders made from clear polystyrene



Art.-Nr.	Farbe	Abmessungen (BxHxT)	VPE
UMSD009000X1000	Transparent	95 x 55 x 39	40

## Tastaturablage | Keyboard Tray

- Ergonomische Tastaturablage für bequemes Arbeiten
- Rutschfest durch transparente Gummi-Füße und Gummiprofil
- Verwendbar für fast alle Tastaturen
- Glänzend polierte Kanten
- UV-beständiges, glasklares Acrylglas
- Ergonomic keyboard tray for comfortable work
- Non-slip thanks to transparent rubber feet and rubber profile
- Suitable for almost all keyboards
- Shiny polished edges
- UV-resistant, crystal clear acrylic glass



Art.-Nr.	Ausführung	Format (mm)
UMSKBS0017X2000	Tastatur Ablage	432 x 42 x 155 mm



## Netzteile



Netzteile.  
Power Supplies.

Art.-Nr.	Leistung
UYUP445440X1000	1 Ampere
UYUP445450X1000	2 Ampere
UYUP445460X1000	3 Ampere
UYUP445490X1000	4 Ampere
UYUP445510X1000	5 Ampere
UYUP445520X1000	6 Ampere

## Schreibfolie, DIN A1



Schreibfolie DIN A1.  
Write-on-film DIN A1.

Art.-Nr.	Farbe
6100001	Schwarz

## Prospektkorb, DIN A4 für Kundenstopper Classic



Prospektkorb DIN A4 für Kundenstopper Classic, für Traverse.  
DIN A4 brochure basket for A-Board to hang on scissors.

Art.-Nr.	Format (DIN)
UYTS3000A4X1000	A4

## Aufsatzhalterung für Topschild

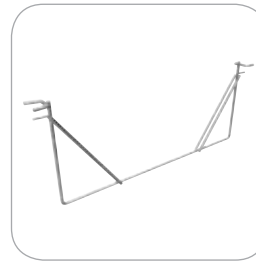

Aufsatzhalterung für Topschild.  
A-Board header holder.

Art.-Nr.	Format (DIN)
UYTT0000A2X1000	A2
UYTT0000A1X1000	A1
UYTT0000A0X1000	A0
UYTT0000B2X1000	B2
UYTT0000B1X1000	B1

## Topschild für Kundenstopper und WindPro



Topschild für Kundenstopper.  
A-Board header.

Topschild für WindPro.  
A-Board header for WindPro.

Nr.	Art.-Nr.	Format (DIN)
1)	UYFT0000A2X1000	A2
1)	UYFT0000A1X1000	A1
1)	UYFT0000A0X1000	A0
1)	UYFT0000B2X1000	B2
1)	UYFT0000B1X1000	B1
2)	UYFT0030A1X1000	A1
2)	UYFT0030A0X1000	A0
2)	UYFT0030B2X1000	B2
2)	UYFT0030B1X1000	B1

## Deckenabhängesets, 1,5 m



2 x Stahlseil 1,5 mm stark, verzinkt.  
Steel wire ceiling suspension set.

Art.-Nr.	Beschreibung
2100005	für doppels. Klapprahmen DIN A4, inkl. Schienengleiter für Leuchtkasten, inkl. Bilderhaken "Fixmatic"
2100002	für Klapprahmen, inkl. verstellbaren Bilderhaken

## Folientasche für Kundenstopper wasserfest



Folientasche für Kundenstopper wasserfest.  
Waterproof poster pocket for A-Boards.

Art.-Nr.	Plakatformat	Folie (mm)
UYUP088100X5279	DIN A1	613 x 860
UYUP088100X5280	DIN A0	860 x 1208
UYUP088100X5305	700 x 1000	719 x 1019

## PET Folie, glasklar



PET-Schutzfolie, glasklar.  
PET cover-sheet, crystal clear.

Art.-Nr.	Format
UYUP088000X5185	700 x 1000

## Antireflex Schutzfolie, B1 zertifiziert



Antireflex-Schutzfolie für FireProtection Klapprahmen, B1 zertifiziert.  
Antireflex cover-sheet sheet for FireProtection Snap Frame, B1 certification.

Art.-Nr.	Format
UYUP033020X2000	DIN A4
UYUP033030X2000	DIN A3
UYUP033040X2000	DIN A2
UYUP033010X2000	DIN A1
UYUP033050X2000	DIN A0
UYUP033060X2000	500 x 700 mm
UYUP033070X2000	700 x 1000 mm
UYUP033080X2000	1000 x 1400 mm

## Antireflex Schutzfolie für wasserfeste Klapprahmen



Antireflex PET-Schutzfolie.  
Antireflex PET cover-sheet.

Art.-Nr.	Plakatformat (mm)	Folie (mm)
UYUP088400X1000	A3	330 x 453
UYUP088410X1000	A2	453 x 627
UYUP088420X1000	A1	627 x 874
UYUP088430X1000	A0	874 x 1222
UYUP088440X1000	B2	533 x 733
UYUP088450X1000	B1	733 x 1033

## Antireflex PET-Schutzfolie für Klapprahmen, Eco A-Board und WindPro LITE



Antireflex PET-Schutzfolie.  
Antireflex PET cover-sheet.

Art.-Nr.	Format (DIN)
UYUP083000X1000	A4
UYUP084000X1000	A3
UYUP085000X1000	A2
UYUP083000X1000	A1
UYUP086000X1000	A0
UYUP087000X1000	B2
UYUP088000X1000	B1
UYUP089000X1000	B0

## Antireflex PET-Schutzfolie für WindPro "Standard"



Antireflex PET-Schutzfolie.  
Antireflex PET cover-sheet.

Art.-Nr.	Plakatformat (mm)	Folie (mm)
UYUP081010X1000	420 x 594	449 x 623
UYUP081020X2000	594 x 841	623 x 870
UYUP081030X1000	841 x 1189	870 x 1218
UYUP081040X1000	500 x 700	529 x 729
UYUP081050X1000	700 x 1000	729 x 1029
UYUP081060X1000	1000 x 1400	1029 x 1429

## Antireflex PET-Schutzfolie für WindPro PLUS



Antireflex PET-Schutzfolie.  
Antireflex PET cover-sheet.

Art.-Nr.	Plakatformat (mm)	Folie (mm)
UYUP082060X1000	A1	625 x 889
UYUP082050X1000	A0	872 x 1237
UYUP082000X1000	500 x 700	531 x 748
UYUP082070X1000	700 x 1000	731 x 1048

**Gültigkeit / AGB's**

Dieser Katalog ist gültig ab 11. Oktober 2021.  
Alle früheren Kataloge verlieren hiermit ihre Gültigkeit.  
Irrtümer und technische Änderungen bleiben vorbehalten.  
Lieferungen erfolgen ausschließlich gemäß unseren AGB, die wir Ihnen gerne  
auf Wunsch zur Verfügung stellen.

**Sonstiges**

Druckfehler, Irrtümer und Änderungen zum Inhalt, Text und Abbildungen der  
angebotenen Produkte vorbehalten.

**Validity / Terms & Conditions**

*This catalog is valid from 11th October 2021.  
All prior catalogs are void.  
Errors and technical specifications are subject to change without notice.  
Our general terms and conditions apply to all deliveries.  
Delivered goods remain to property of update displays until payment in full.*

**Others**

*Printing errors, mistakes and changes to the content, text and pictures of the  
offered products are reserved.*

